

EZ-ZONE® ST

User's Manual



Integrated Control Loop



1241 Bundy Boulevard., Winona, Minnesota USA 55987
Phone: +1 (507) 454-5300, Fax: +1 (507) 452-4507 <http://www.watlow.com>



Safety Information

We use note, caution and warning symbols throughout this book to draw your attention to important operational and safety information.

A “NOTE” marks a short message to alert you to an important detail.

A “CAUTION” safety alert appears with information that is important for protecting your equipment and performance. Be especially careful to read and follow all cautions that apply to your application.

A “WARNING” safety alert appears with information that is important for protecting you, others and equipment from damage. Pay very close attention to all warnings that apply to your application.

The safety alert symbol,  (an exclamation point in a triangle) precedes a general CAUTION or WARNING statement.

The electrical hazard symbol,  (a lightning bolt in a triangle) precedes an electric shock hazard CAUTION or WARNING safety statement.



CAUTION or WARNING



**Electrical Shock Hazard
CAUTION or WARNING**

Warranty

The EZ-ZONE™ ST is manufactured by ISO 9001-registered processes and is backed by a three-year warranty to the first purchaser for use, providing that the units have not been misapplied. Since Watlow has no control over their use, and sometimes misuse, we cannot guarantee against failure. Watlow’s obligations hereunder, at Watlow’s option, are limited to replacement, repair or refund of purchase price, and parts which upon examination prove to be defective within the warranty period specified. This warranty does not apply to damage resulting from transportation, alteration, misuse or abuse. The purchaser must use Watlow parts to maintain all listed ratings.

Technical Assistance

If you encounter a problem with your Watlow controller, review your configuration information to verify that your selections are consistent with your application: inputs, outputs, alarms, limits, etc. If the problem persists, you can get technical assistance from your local Watlow representative (see back cover), by e-mailing your questions to wintechsupport@watlow.com or by dialing +1 (507) 494-5656 between 7 a.m. and 5 p.m., Central Standard Time (CST). Ask for an Applications Engineer. Please have the following information available when calling:

- Complete model number
- All configuration information
- User’s Manual
- Factory Page

Warranty

The EZ-ZONE® ST is manufactured by ISO 9001-registered processes and is backed by a three-year warranty to the first purchaser for use, providing that the units have not been misapplied. Since Watlow has no control over their use, and sometimes misuse, we cannot guarantee against failure. Watlow’s obligations hereunder, at Watlow’s option, are limited to replacement, repair or refund of purchase price, and parts which upon examination prove to be defective within the warranty period specified. This warranty does not apply to damage resulting from transportation, alteration, misuse or abuse.

Return Material Authorization (RMA)

1. Call Watlow Customer Service, (507) 454-5300, for a Return Material Authorization (RMA) number before returning any item for repair. If you do not know why the product failed, contact an Application Engineer or Product Manager. All RMA’s require:

- Ship-to address
- Bill-to address
- Contact name
- Phone number
- Method of return shipment
- Your P.O. number
- Detailed description of the problem
- Any special instructions
- Name and phone number of person returning the product.

2. Prior approval and an RMA number from the Customer Service Department is required when returning any product for credit, repair or evaluation. Make sure the RMA number is on the outside of the carton and on all paperwork returned. Ship on a Freight Prepaid basis.

3. After we receive your return, we will examine it and try to verify the reason for returning it.

4. In cases of manufacturing defect, we will enter a repair order, replacement order or issue credit for material returned. In cases of customer mis-use, we will provide repair costs and request a purchase order to proceed with the repair work.

5. To return products that are not defective, goods must be in new condition, in the original boxes and they must be returned within 120 days of receipt. A 20 percent restocking charge is applied for all returned stock controls and accessories.

6. If the unit is not repairable, you will receive a letter of explanation, and be given the option to have the unit returned to you at your expense or to have us scrap the unit.

7. Watlow reserves the right to charge for no trouble found (NTF) returns.

The EZ-ZONE® ST User’s Manual is copyrighted by Watlow Electric, Inc., © April 2010 with all rights reserved.

EZ-ZONE® ST is covered by U.S. Patent No. 6,005,577 and Patents Pending

Table of Contents

Chapter 1: Overview	3
The EZ-ZONE® ST Provides Total Thermal System Control	3
A Conceptual View of the ST	4
Getting Started Quickly	5
Chapter 2: Install, Wire and Set Address	7
Wiring	9
Installation	14
Replacing the Solid-State Relay	15
ST Isolation Block	17
Setting the Address	26
Conventions Used in the Menu Pages	27
Chapter 3: Operations Pages	30
Analog Input Menu	31
Digital Input/Output Menu	32
Limit Menu	32
Monitor Menu	32
Loop Menu	33
Alarm Menu	35
Current Menu	36
Profile Status Menu	37
Chapter 4: Setup Pages	39
Analog Input Menu	40
Digital Input/Output Menu	42
Limit Menu	44
Control Loop Menu	44
Output Menu	47
Alarm Menu	48
Current Menu	50
Function Key	51
Global Menu	52
Communications Menu	53
Chapter 5: Profiling Page	54
Chapter 6: Factory Pages	59
Custom Setup Menu	60
Security Setting Menu	60
Security Setting Menu	62
Diagnostics Menu	62
Calibration Menu	63
Chapter 7: Features	64
Saving and Restoring User Settings	65
Tuning the PID Parameters	65
Inputs	66
Control Methods	68
Alarms	72
Using Lockout to Hide Pages and Menus	73



Table of Contents (cont.)

Modbus - Using Programmable Memory Blocks.....	75
CIP - Communications Capabilities	75
Software Configuration	76
Chapter 8: Appendix	79
Troubleshooting.....	79
Modbus - Programmable Memory Blocks.....	82
CIP Implicit O to T (Originator to Target) Assembly Structure.....	84
CIP Implicit T to O (Target to Originator) Assembly Structure.....	84
Specifications.....	85
Ordering Information	86
Index	89
Declaration of Conformity	93
How to Reach Us.....	95

1

Chapter 1: Overview

The EZ-ZONE® ST Provides Total Thermal System Control

The EZ-ZONE ST solid-state controller offers complete thermal system control in a single package while reducing system complexity and the cost of control-loop ownership. You can order a PID controller already connected to a high-amperage, solid-state relay capable of zero cross or phase angle firing with the option of adding a properly sized heat sink, an over-under temperature limit, a shut-down power contactor, and digital communications in one package.

It just got a whole lot easier to solve the thermal requirements of your system. Because the EZ-ZONE ST along with the entire family of EZ-ZONE controls are highly scalable where you pay only for what you need. So if you are looking for a PID controller with high amperage outputs, an over-under limit controller or an integrated controller, the EZ-ZONE ST is the answer.

Features and Benefits

Back panel or DIN rail mount

- Provides several mounting options

Compact package



- Reduces panel size

Touch-safe package

- IP2X-Touch safe with back of hand
- Increases safety for installers and operators

±0.1 percent temperature accuracy

- Provides efficient and accurate temperature control

Agency approvals:  (with factory-installed heatsink);  (without factory-installed heatsink); CE; RoHS; W.E.E.E.; CSA

- Limit version features FM approval
- Provides third-party recognition

Three-year warranty

- Provides Watlow reliability and product support

Off-the-shelf designed system solution

- Improves system reliability and reduces wiring
- Reduces installation cost
- Eliminates compatibility headaches often encountered when using many different components and brands

Profile capability

- Includes ramp and soak with four files and forty steps

Communications with PLC, PC or HMI

- ST with optional Modbus® RTU protocol

- When used with the optional Remote User Interface/Gateway (RUI/GTW) the following protocols are available:

- EIA 232/485 Modbus RTU
- Modbus TCP
- EtherNet/IP
- DeviceNet
- Profibus DP

Solid-State Relay output

- Provides faster cycling, more precise control, increased heater life and energy efficiency
- Resistive or inductive load current of up to 75 amperes using either zero-cross or phase angle control modes
- Soft start feature with phase angle control mode to prevent load failure or blowing fuses

PID temperature control

- Provides accurate temperature control
- Provides a single input and dual outputs
- Provides standard or adaptive (TRU-TUNE+) PID tuning algorithms.

Optional temperature limit

- Increases safety during under and over-temperature conditions

Optional definite purpose mechanical contactor

- Enables circuit safety shutdown driven by a limit controller or a PID alarm output signal

Optional current monitoring feature

- Detects heater current flow and alarm indication of failed Solid-State Relay or a heater zone

Optional Solid-State Relay heat sink

- Sized and engineered for specific applications
- Factory assembled heat sink required for UL listing

System diagnostics

- Provides continuous system level monitoring with alerts reducing the overall cost for maintenance and service

Advanced controllability algorithms

- TRU-TUNE+™ meets demanding controllability requirements.

PC Software: EZ-ZONE ST Configurator

- Wizard-style configuration of controller settings
- Online or offline recipe editing

UL® is a registered trademark of Underwriter's Laboratories Inc.
Modbus™ is a trademark of Schneider Automation Incorporated.

A Conceptual View of the ST

The flexibility of the ST software and hardware allows a large range of configurations. Acquiring a better understanding of the controller's overall functionality and capabilities while at the same time planning out how the controller can be used will deliver maximum effectiveness in your application.

It is useful to think of the controller in terms of functions; there are internal and external functions. An input and an output would be considered external functions where the PID calculation would be an internal function. Information flows from an input function to an internal function to an output function when the controller is properly configured. A single ST control can carry out several functions at the same time. For instance, closed-loop control monitoring for several different alarm situations, while at the same time operating switched devices, such as lights and motors. Each process needs to be thought out carefully and the controller's various functions set up properly.

Inputs Functions

The inputs provide the information that any given programmed procedure can act upon. In a simple form, this information may come from an operator pushing a button or as part of a more complex procedure it may represent a remote set point being received from another controller.

Each analog input typically uses a thermocouple or RTD to read the temperature of something. It can also read volts, current or resistance, allowing it to use various devices to read humidity, air pressure, operator inputs and others values. The settings in the Analog Input Menu (Setup Page) for each analog input must be configured to match the device connected to that input.

Each digital input reads whether a device is active or inactive. A controller with digital input-output (DIO) hardware includes two sets of terminals each. Each DIO must be configured to function as either an input or output with the Direction parameter in the Digital Input/Output Menu (Setup Page).

The EZ-ZONE Remote User Interface (RUI) has a function, or EZ Key on the front panel, this too can be configured as a digital input by toggling the function assigned to it in the Digital Input Function parameter in the Function Key Menu (Setup Page). If interested in learning more about the RUI and how it is used with the ST retrieve the RUI user manual from the Watlow web site. Point your browser to:

http://www.watlow.com/literature/pti_search.cfm?dltype=5

Once there, type in EZ-ZONE for a keyword at the bottom of the page and then click on the search button to find the user manual.

Internal Functions

Functions use input signals to calculate a value. A function may be as simple as reading a digital input to

set a state to true or false, or reading a temperature to set an alarm state to on or off. Or, it could compare the temperature of a process to the set point and calculate the optimal power for a heater.

To set up a function, it's important to tell it what source, or instance, to use. For example, an alarm may be set to respond to either analog input 1 or 2 (instance 1 or 2, respectively).

Outputs Functions

Outputs can perform various functions or actions in response to information provided by a function, such as operating a heater, driving a compressor, turning a light on or off, unlocking a door, turning on a buzzer etc...

Assign an output to a Function in the Output Menu or DIO Menu. Then select which instance of that function will drive the selected output. For example, you might assign an output to respond to alarm 2 (instance 2).

You can assign more than one output to respond to a single instance of a function. For example, alarm 2 could be used to trigger a light connected to output 1 and a siren connected to digital output 5.

Input Events and Output Events

Input and output events are internal states that are used exclusively by profiles. The source of an event input can come from a real-world digital input or an output from another function. Likewise, event outputs may control a physical output such as an output function block or be used as an input to another function.

Getting Started Quickly

The ST control has a page and menu structure that is listed below along with a brief description of its purpose.

<p>Setup Page Push and hold the up and down keys (▲ ▼) for 6 seconds to enter. (See the Setup Page for further information)</p>	<p>Once received, a user would want to setup their control prior to operation. As an example, define the input type and set the output cycle time.</p>
<p>Operations Page Push and hold the up and down keys (▲ ▼) for 3 seconds to enter. (See the Operations Page for further information)</p>	<p>After setting up the control to reflect your equipment, the Operations Page would be used to monitor or change runtime settings. As an example, the user may want to see how much time is left in a profile step or perhaps change the autotune set point.</p>
<p>Factory Page Push and hold the Infinity and the green Advance keys (∞ ⏻) for 6 seconds to enter. (See the Factory Page for further information)</p>	<p>For the most part the Factory Page has no bearing on the control when running. Here, a user may want to enable password protection, view the control part number or perhaps create a custom Home Page.</p>
<p>Profile Page Push and hold the the green Advance key ⏻ for 6 seconds to enter. (See the Profile Page for further information)</p>	<p>If equipped with this feature, a user would want to go here to configure a profile.</p>

The default ST loop configuration out of the box is shown below:

- Analog Input functions set to thermocouple, type J
- Heat algorithm set for PID, Cool set to off
- Output 1 set to Heat
- Control mode set to Auto
- Set point set to 75 °F

If you are using the input type shown above, simply connect your input and output devices to the control. Power up the control and push the up arrow ▲ on the face of the control to change the set point from the default value of 75 °F to the desired value. As the Set Point increases above the Process Value, output 1 will come on and it will now begin driving your output device.

Note:

The output cycle time will have a bearing on the life of mechanical relay outputs and can be different based on the type of output ordered. The output cycle time can be changed in the Setup Page under the Output Menu.

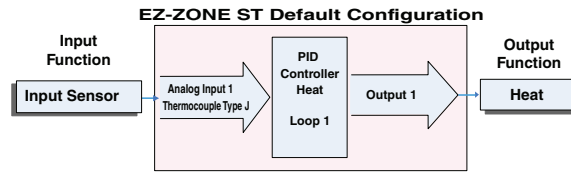

EZ-ZONE® ST System Diagram

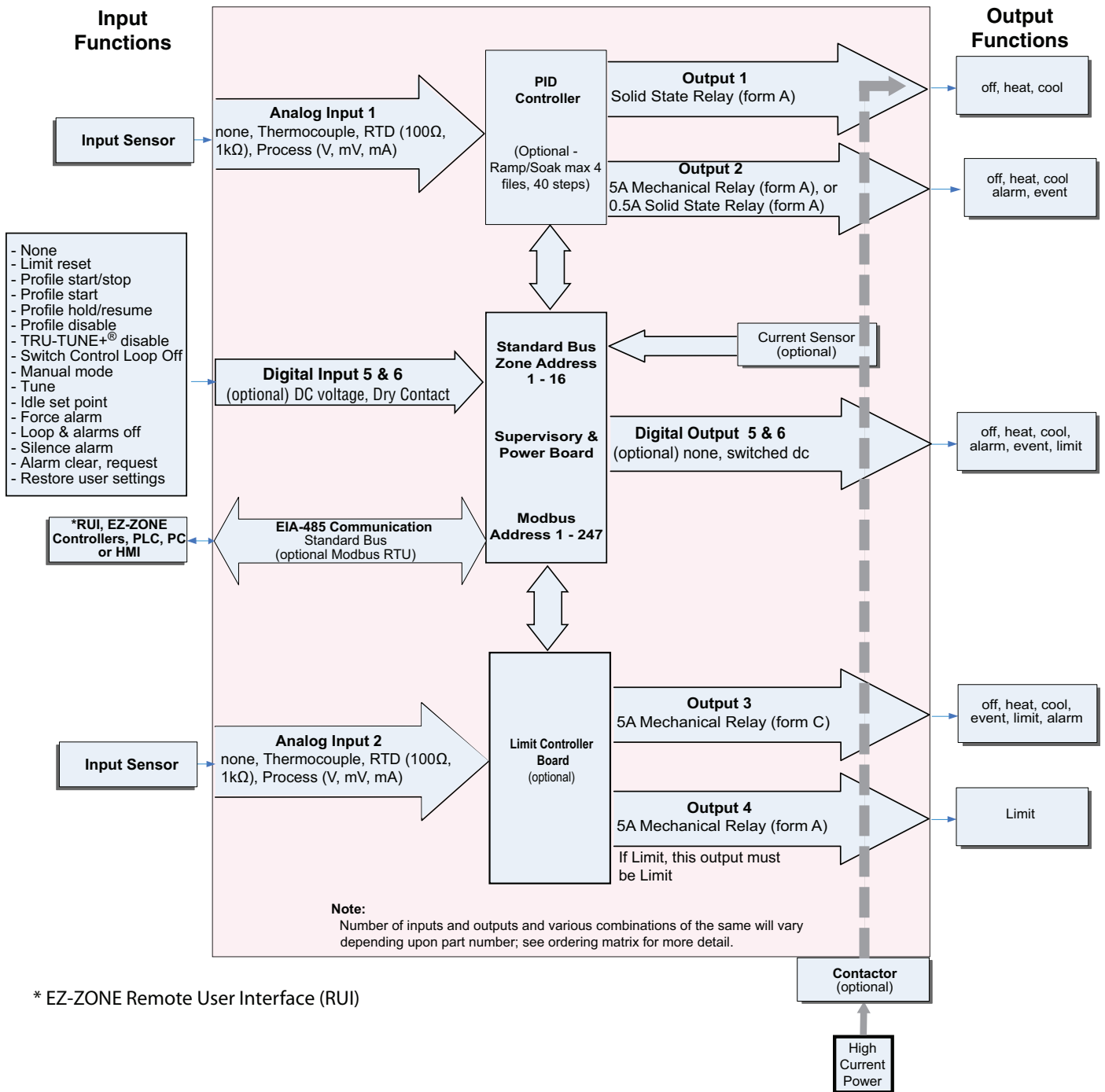

* EZ-ZONE Remote User Interface (RUI)



WARNING: When the controller is powered up, the outputs may turn on.

Note:

A current error can be sent to the RUI (Remote User Interface) soft error display by enabling Current Reading **Cur** in the Setup Page.

2 Chapter 2: Install, Wire and Set Address

EZ-ZONE® ST with 25A or 40A Contactor

WARNING: The heat sink can become hot during operation.

CAUTION: The EZ-ZONE ST must be mounted vertically (as shown) to meet the ampere/ambient-temperature performance curve.

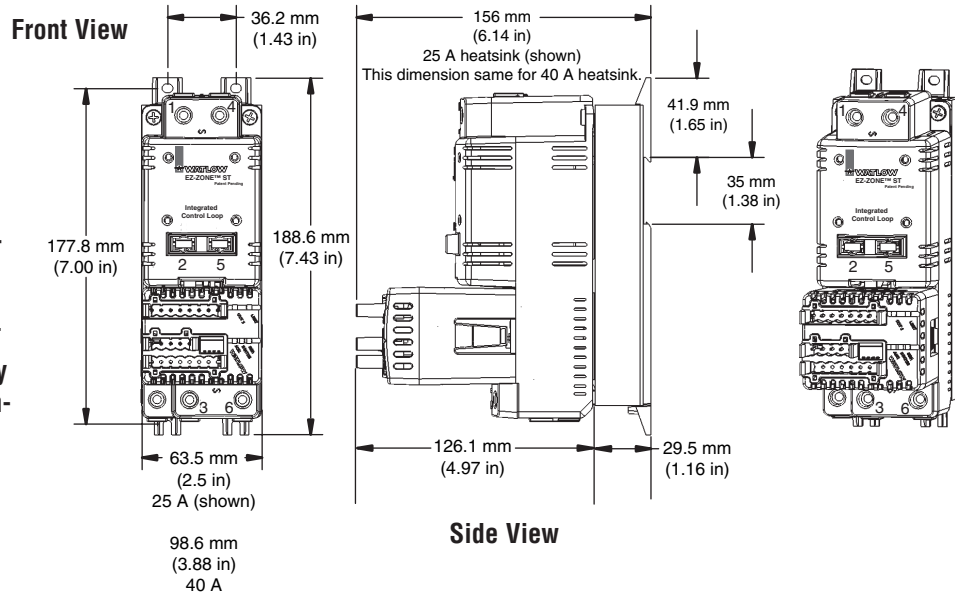

EZ-ZONE ST Without a 25A or 40A Contactor

WARNING: The heat sink can become hot during operation.

CAUTION: The EZ-ZONE ST must be mounted vertically (as shown) to meet the ampere/ambient-temperature performance curve.

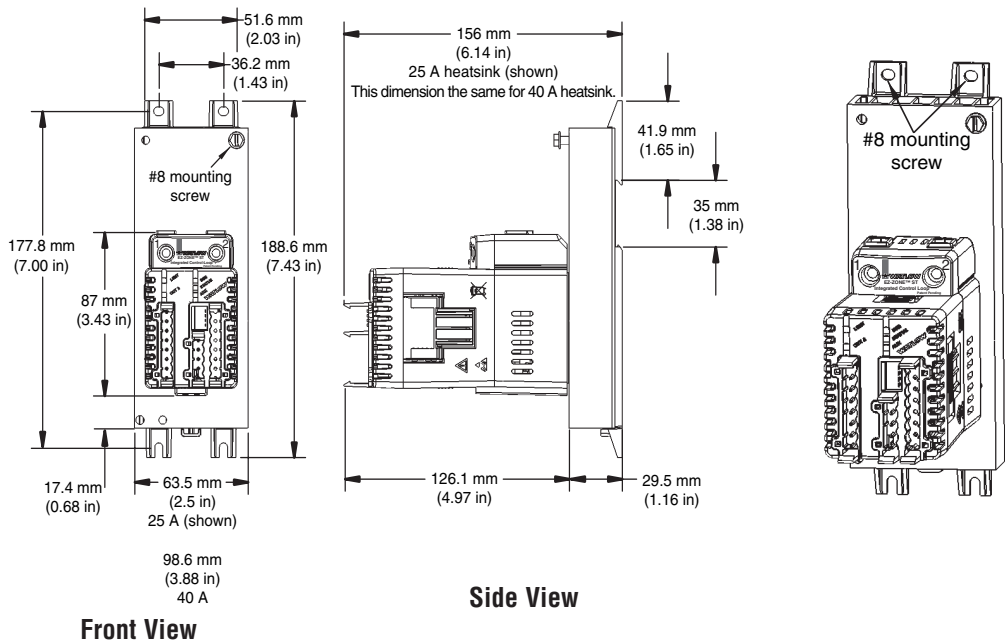

EZ-ZONE ST Without a Contactor

WARNING: The heat sink can become hot during operation.

CAUTION: The EZ-ZONE ST must be mounted vertically (as shown) to meet the ampere/ambient-temperature performance curve.

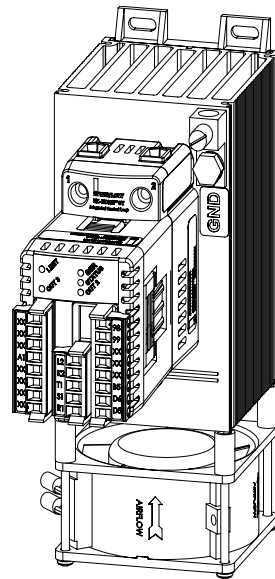
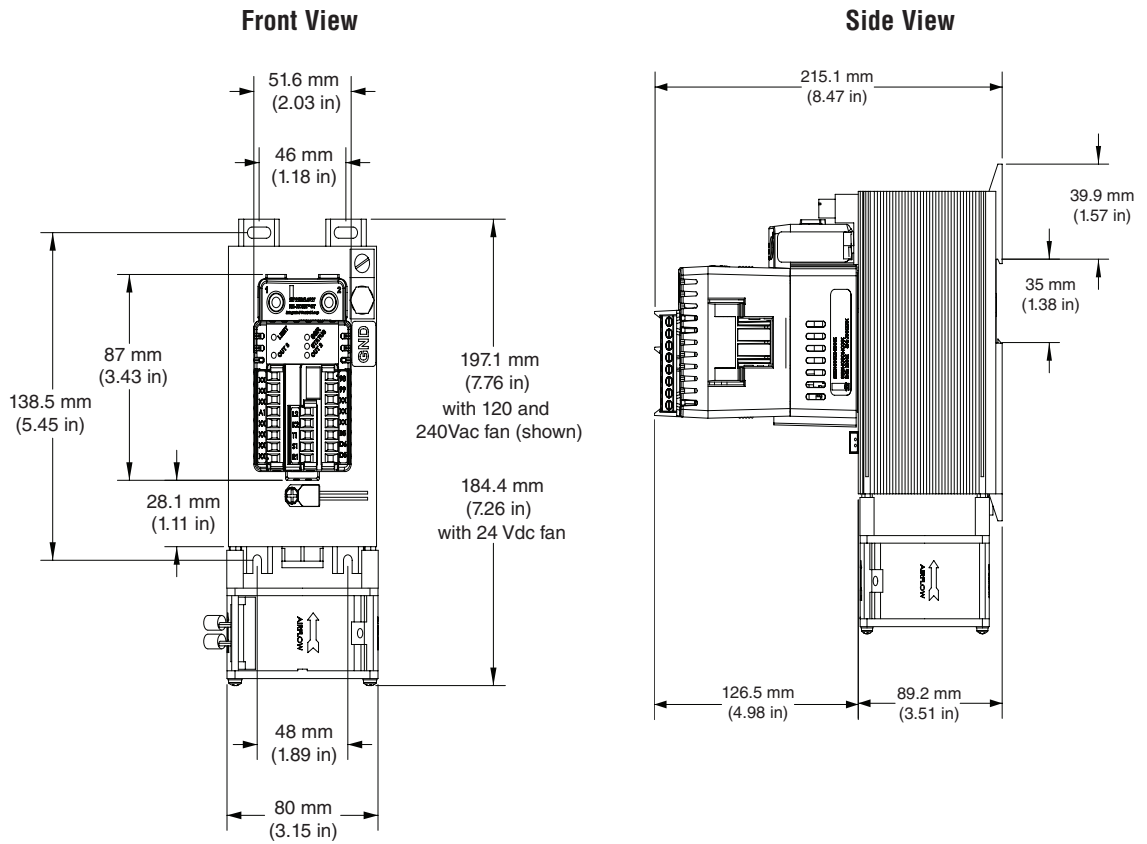



WARNING: Use National Electric (NEC) or other country-specific standard wiring and safety practices when wiring and connecting this controller to a power source and to electrical sensors or peripheral devices. Failure to do so may result in damage to equipment and property, and/or injury or loss of life.

Wiring with a contactor (ST ___ - (B or F) ___ - ___)

Note:

A2 is connected internally to terminal 98. A1 is connected internally to the contactor coil. The other side of the coil is connected to terminal 99.

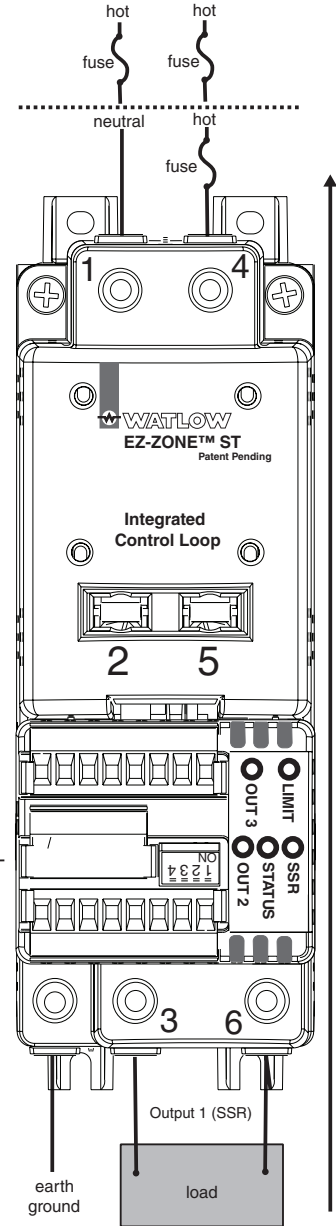
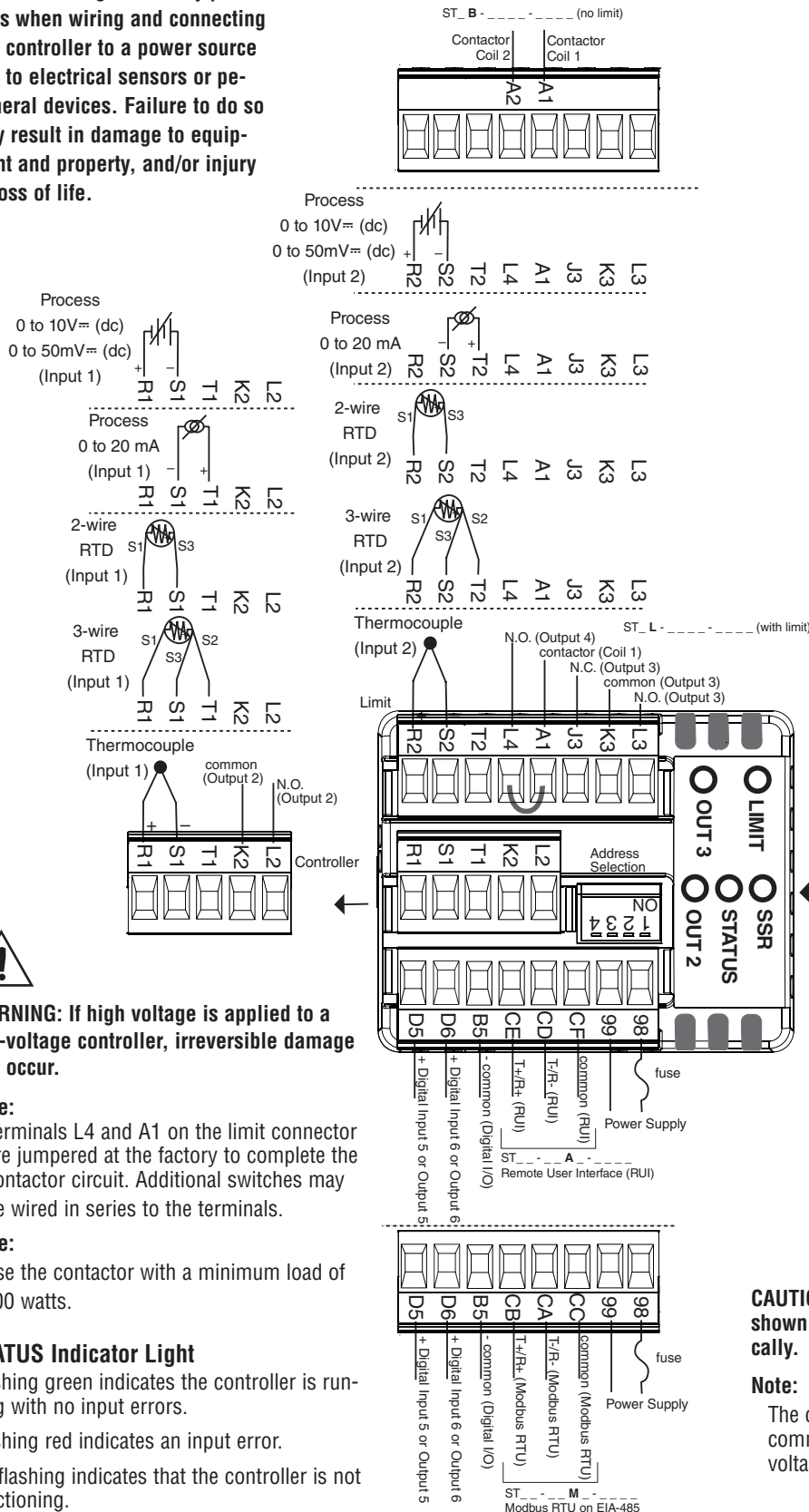

WARNING: If high voltage is applied to a low-voltage controller, irreversible damage will occur.

Note:

Terminals L4 and A1 on the limit connector are jumpered at the factory to complete the contactor circuit. Additional switches may be wired in series to the terminals.

Note:

Use the contactor with a minimum load of 100 watts.

STATUS Indicator Light

Flashing green indicates the controller is running with no input errors.

Flashing red indicates an input error.

No flashing indicates that the controller is not functioning.

CAUTION: Always mount the controller as shown, with the heat-sink fins aligned vertically.

Note:

The control common terminal and the digital common terminal are referenced to different voltages and must remain isolated.

Wiring without a contactor (ST ___ - A _____ - _____)



WARNING: Use National Electric (NEC) or other country-specific standard wiring and safety practices when wiring and connecting this controller to a power source and to electrical sensors or peripheral devices. Failure to do so may result in damage to equipment and property, and/or injury or loss of life.



WARNING: If high voltage is applied to a low-voltage controller, irreversible damage will occur.

CAUTION: Always mount the controller as shown, with the heat-sink fins aligned vertically.

Note:

If 75A heat sink is ordered D6 (Digital Input) will be factory set and used as the SSR over temperature shut-down.

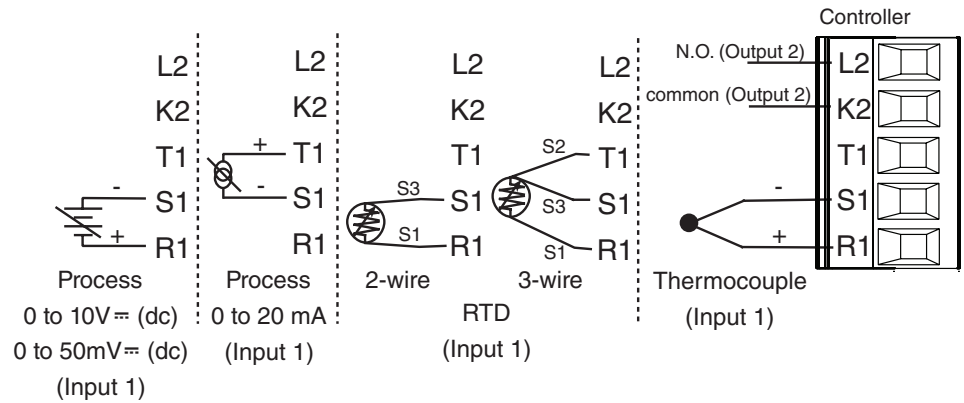
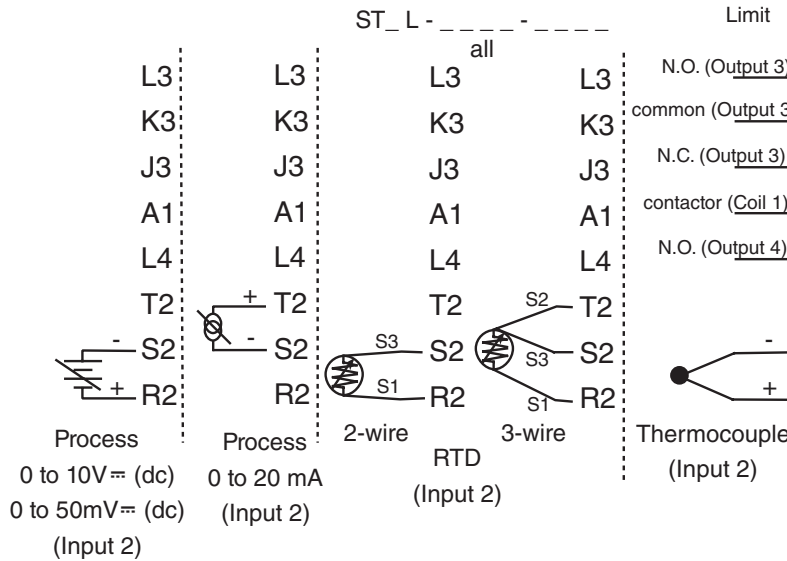
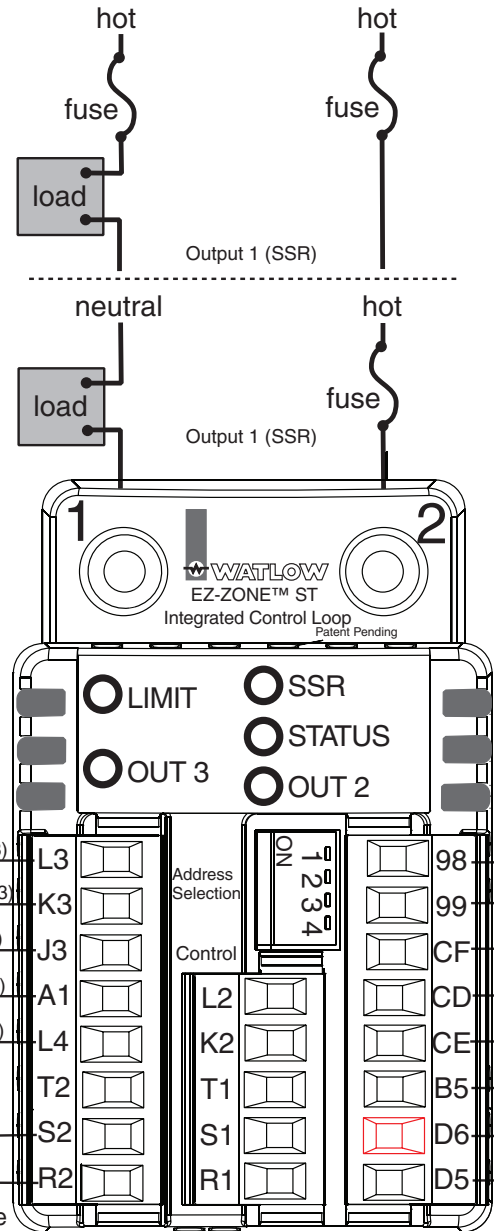

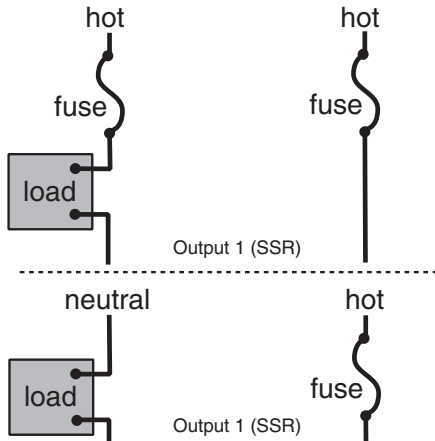

Ground Connection

Connect the ground to the heat sink.
There is no ground connection on models without a heat sink.

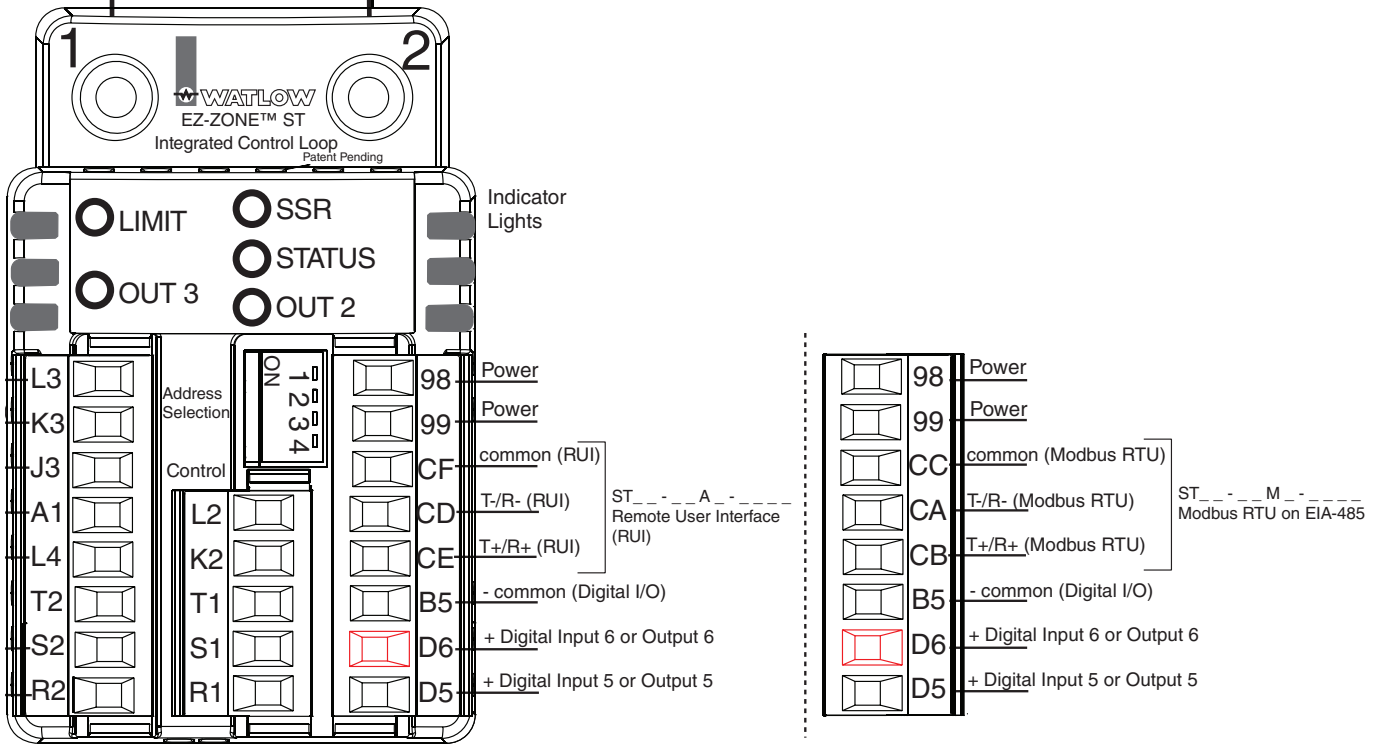

Note:
The control common terminal and the digital common terminal are referenced to different voltages and must remain isolated.

Note:
If 75A heat sink is ordered D6 (Digital Input) will be factory set and used as the SSR over temperature shut-down.

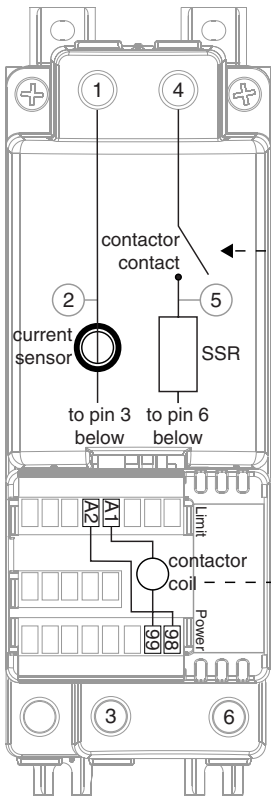

Internal wiring in an ST with a single-pole contactor without a limit (ST _ B - B _ _ _ _ _).

Use single-pole contactors for hot-to-neutral loads. NEC does not permit neutral to be switched.

Use double-pole contactors for hot-to-hot loads. Both hot legs must be opened together on limit conditions to remove power from circuit.

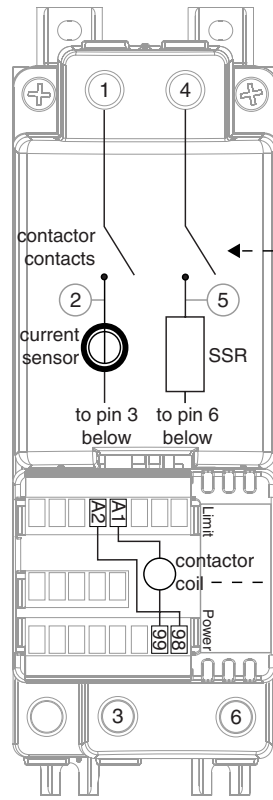

Internal wiring in an ST with a double-pole contactor without a limit (ST _ B - F _ _ _ _ _).

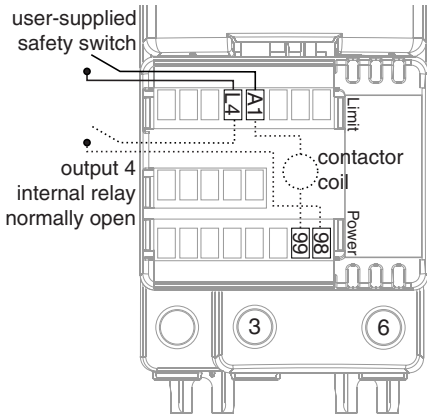

You may remove the factory-installed jumper between A1 and L4 to install a safety switch for the limit relay (ST _ L - _ _ _ _ _).

(Dotted lines represent internal wiring.)

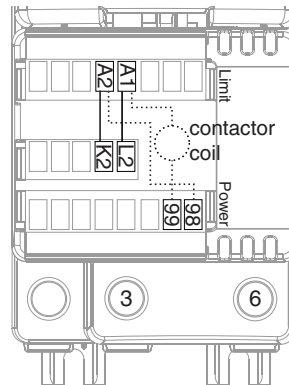

You can use output 2 (L2 and K2) to deactivate the contactor coil on an ST without a limit (ST _ B - _ _ _ _ _).

(Dotted lines represent internal wiring.)

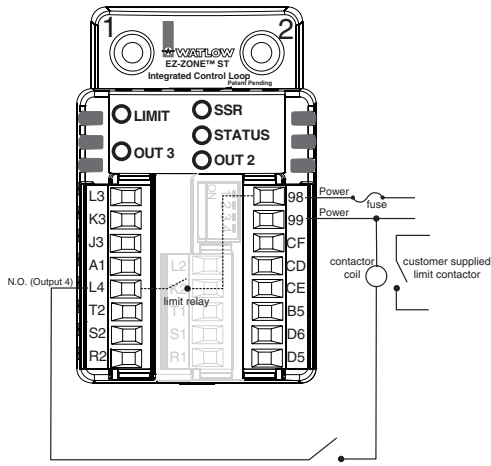

System with a limit using an external contactor (ST _ L _ A _ _ _ _).

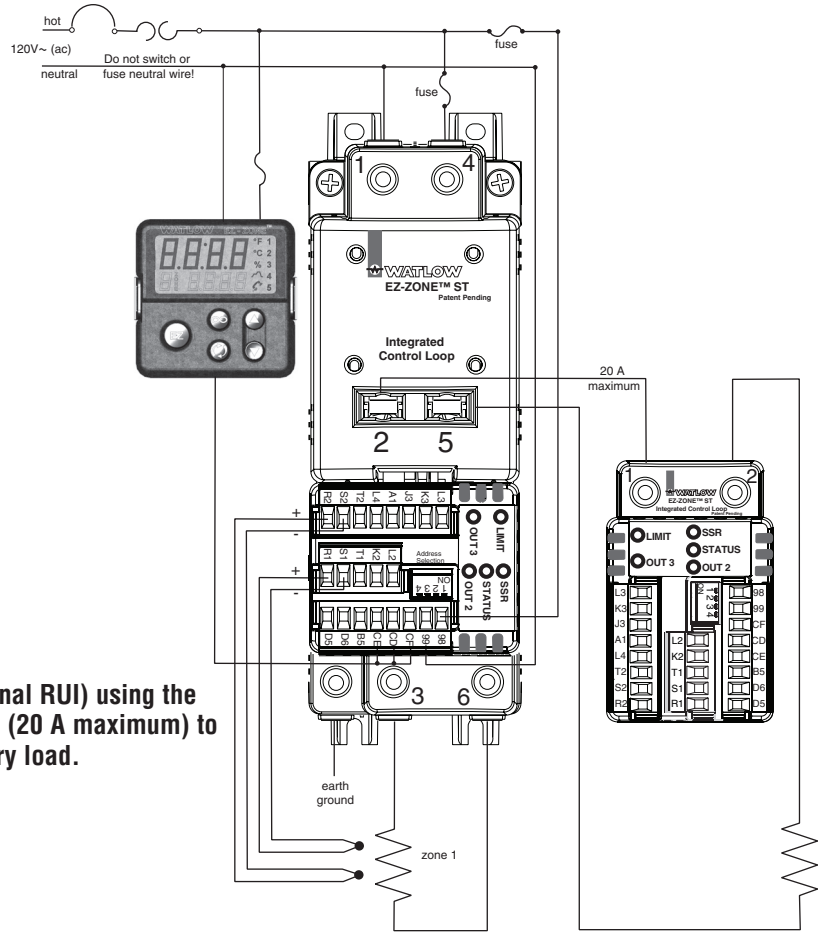

System (with optional RUI) using the auxiliary terminals (20 A maximum) to operate a secondary load.

Sub-assembly Labels

Controller label.

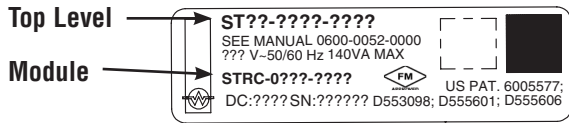

The model number at the top of each label identifies the controller configuration.

See Ordering Information and Model Numbers in the Appendix for more detailed information.

- ST _ _ L _ _ _ 24 to 28V ≈ (ac/dc)
- ST _ _ H _ _ _ 100 to 240V ≈ (ac/dc)
- ST _ _ 1 _ _ _ 24V~ (ac)
- ST _ _ 2 _ _ _ 120V~ (ac)
- ST _ _ 3 _ _ _ 208 to 240V~ (ac)

Heat sink label.

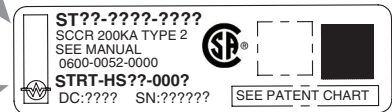

Base label.

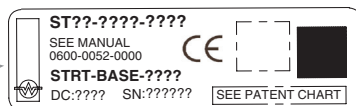

Patent Numbers

Heat Sink	ST??-????-B???	US PAT. 5598322; D531138
	ST??-????-C???	US PAT. 5598322; D529874
Base	ST??-A??-????	US PAT. D553581; D558683
	ST??-[B,F]??-????	US PAT. D553094; D553099

Installation

Mounting and Dismounting the Controller from a DIN Rail

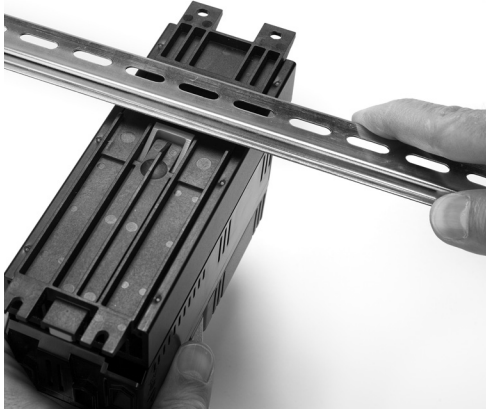

To mount the controller on a DIN rail, first hook the top flange on the back of the heat sink on to the top of the DIN rail. Then rotate the controller to an upright position until the lower flange snaps into place.

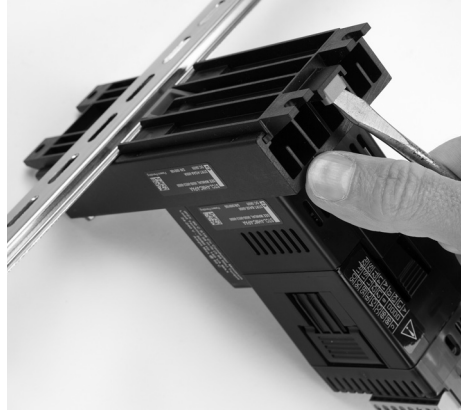

To dismount the controller, first use a screwdriver to pull down the small lever on the bottom of the heat sink and rotate the bottom of the controller forward. Then lift the the controller off of the rail.



Note:

Typically, the DIN rail is mounted before components are mounted on it.

Replacing the Solid-State Relay on a Controller without a Contactor (ST __-A ____-____)

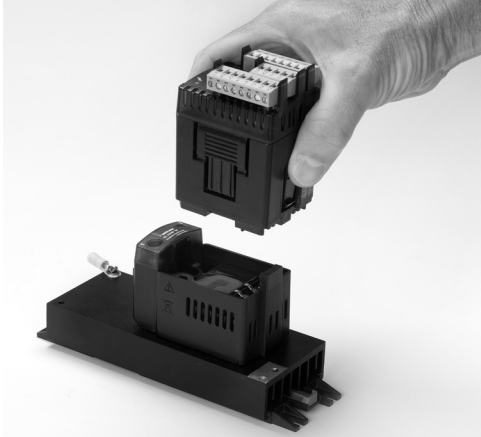

1. Pinch the release levers on the top and bottom of the control module and lift the bottom edge forward to detach the unit.

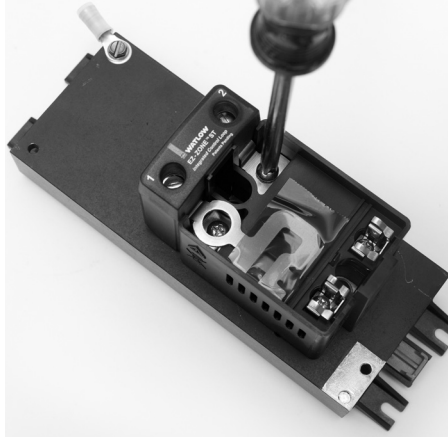

2. With a Phillips screwdriver, remove the four nearest screws that were under the module.

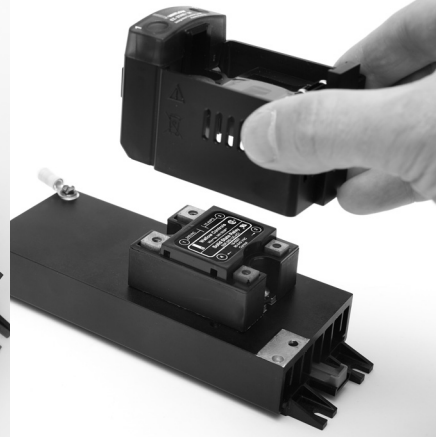

3. Lift the controller body, exposing the solid-state relay.

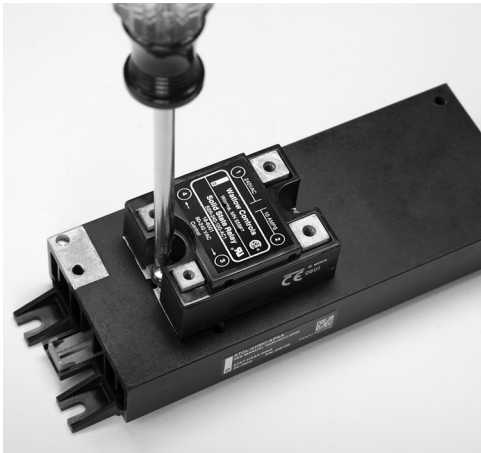

4. Using a Phillips screwdriver, remove the two screws connecting the solid-state relay to the heat sink.

Replacing the Solid-State Relay

1. Using a Phillips screwdriver, replace the two screws connecting the solid-state relay to the heat sink.

2. Place the controller body over the solid-state relay and, using a Phillips screwdriver, replace the four screws securing it.

3. Snap the control module in place, bottom edge first.

Note:

For controller models without a contactor (ST __-A ____-____), the solid-state relay must be mounted with the larger power terminals on the top and the smaller control terminals on the bottom.

Note:

Factory calibration is done using control and base modules as matched pairs. Due to this fact, current detection (if turned on) may not read accurately if a control module is placed into another base module.

Replacing the Solid-State Relay on a Controller with a Contactor (ST __ - (B or F) ___ - ___)



1. Pinch the release levers on the top and bottom of the control module and lift the right edge forward to detach the unit.

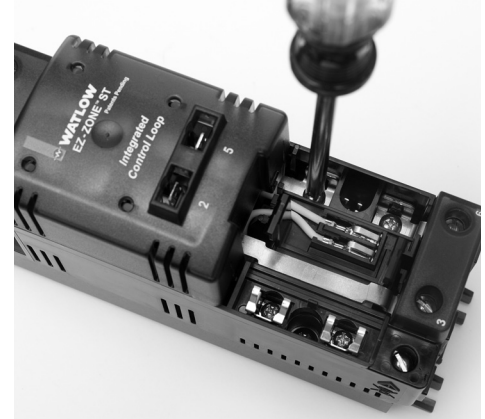

2. With a Phillips screwdriver, remove the four nearest screws that were under the module.



3. With a Phillips screwdriver, remove the two screws at the top corners of the controller.

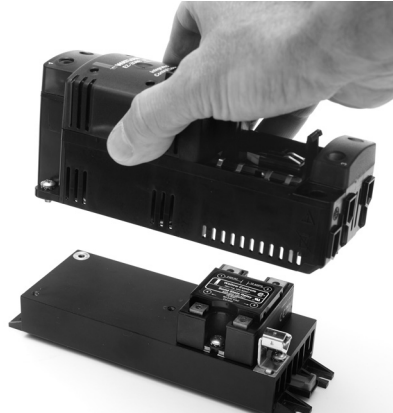

4. Lift the controller body, exposing the solid-state relay.

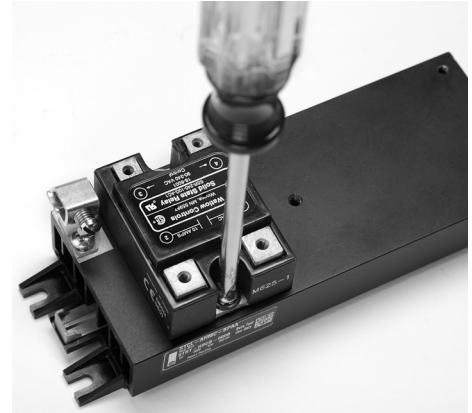

5. Using a Phillips screwdriver, remove the two screws connecting the solid-state relay to the heat sink.

Replacing the Solid-state Relay

1. Using a Phillips screwdriver, replace the two screws connecting the solid-state relay to the heat sink. Check that the bottom of the solid-state relay is on the left.
2. Place the controller body over the solid-state relay and, using a Phillips screwdriver, replace the six screws securing it.
3. Snap the control module in place, left edge first.

Note:

For controller models with a contactor (ST __ -A ___ - ___), the solid-state relay must be mounted with the larger power terminals on the right and the smaller control terminals on the left.

Indicator Lights and Slot Identification

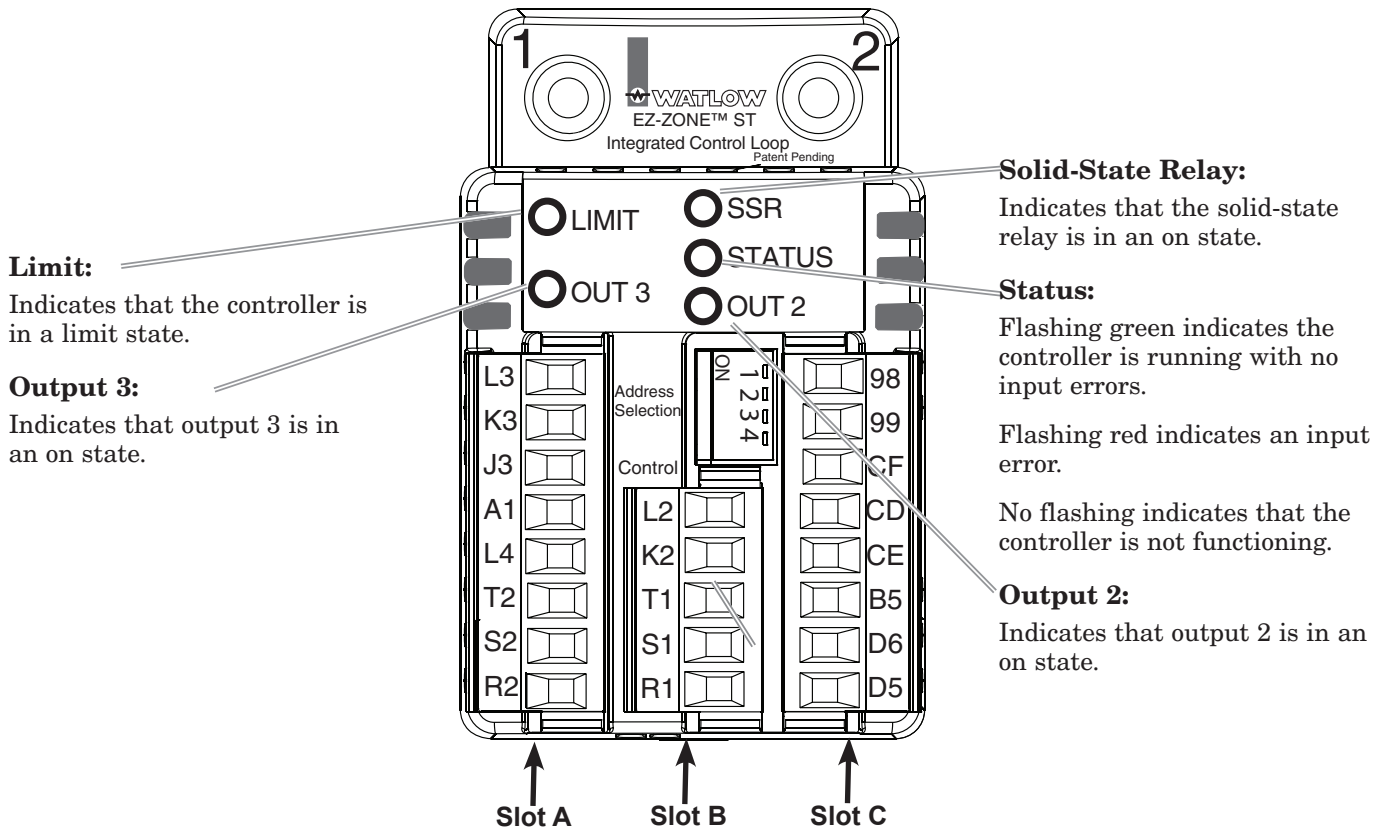

ST Isolation Block

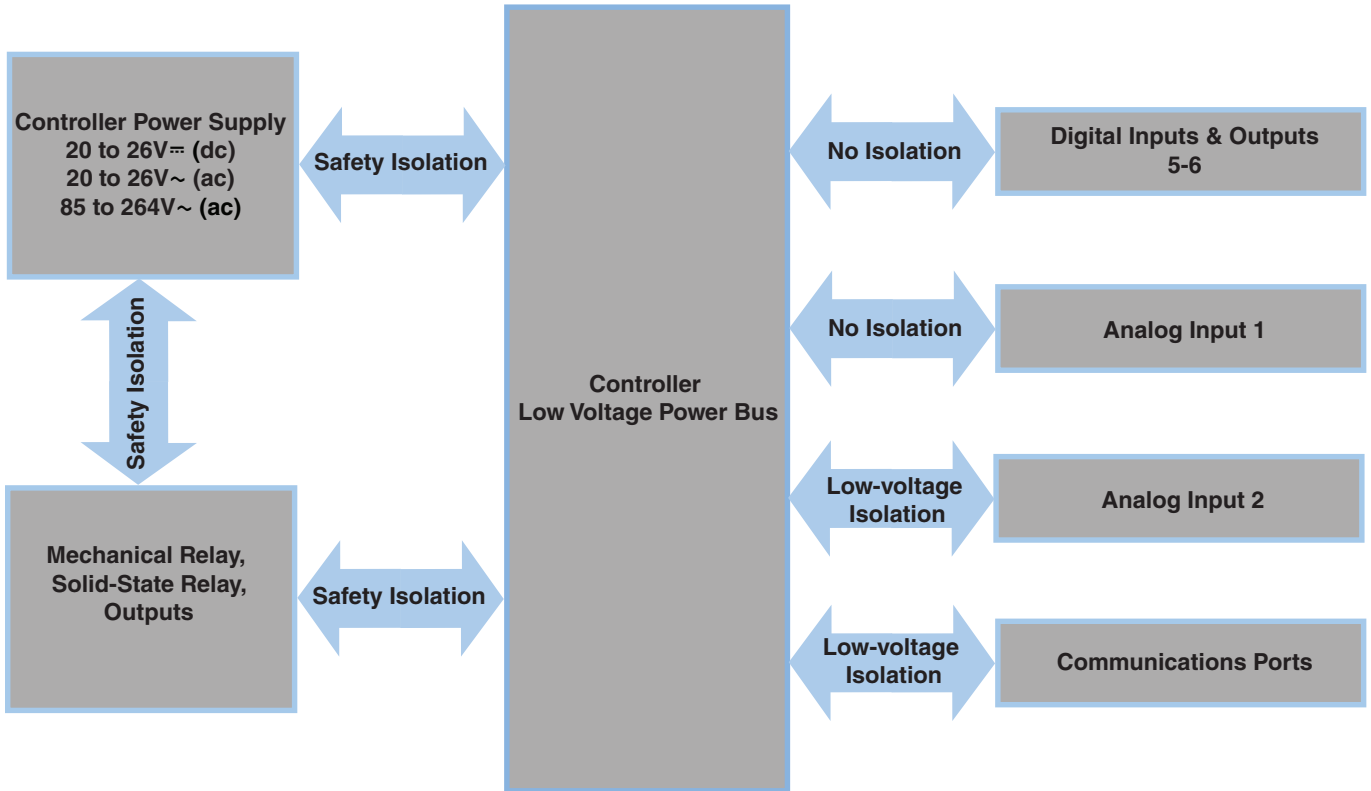

Low-voltage Isolation: 42V peak
Safety Isolation: 2300V~ (ac)



Warning:
Use National Electric (NEC) or other country-specific standard wiring and safety practices when wiring and connecting this controller to a power source and to electrical sensors or peripheral devices. Failure to do so may result in damage to equipment and property, and/or injury or loss of life.

NOTE: To prevent ground loops, isolation needs to be maintained from input to output when using switched DC or analog process outputs.

CAUTION: Always mount the controller with the heat-sink fins aligned vertically.

NOTE: Terminals L4 and A1 on the limit connector are jumpered at the factory to complete the contactor circuit. Additional switches may be wired in series to the terminals.



WARNING: If high voltage is applied to a low-voltage controller, irreversible damage will occur.

Power

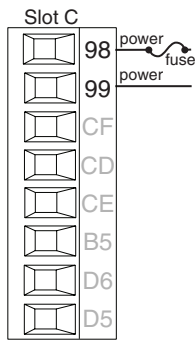

- Minimum/Maximum Ratings
- 85 to 264V~ (ac)
- 20.4 to 26.4 V~ (ac) / V= (dc)
- 47 to 63 Hz
- 12VA maximum power consumption without mechanical contactor in system
- 50VA maximum power consumption with mechanical contactor in system, 140VA if using external contactor

Input 1 Thermocouple

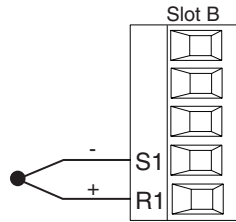

- 20 kΩ maximum source resistance
- >20 MΩ input impedance
- 3 microampere open-sensor detection
- Thermocouples are polarity sensitive. The negative lead (usually red) must be connected to S1.
- To reduce errors, the extension wire for thermocouples must be of the same alloy as the thermocouple.

ST _ _ - _ _ _ _ - _ _ _ _ (all)

Input 1 RTD

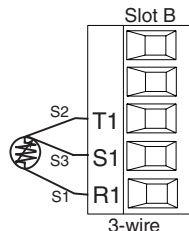
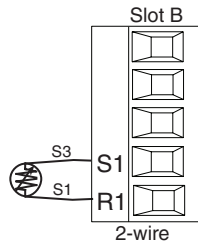

- platinum, 100 and 1,000 Ω @ 0°C
- calibration to DIN curve (0.00385 Ω/Ω/°C)
- 20 Ω maximum lead resistance
- RTD excitation current of 0.09 mA typical. Each ohm of lead resistance may affect the reading by 0.03°C.
- For 3-wire RTDs, the S1 lead (usually white) must be connected to R1.
- For best accuracy use a 3-wire RTD to compensate for lead-length resistance. All three lead wires must have the same resistance.

ST _ _ - _ _ _ _ - _ _ _ _ (all)

Input 1 Process

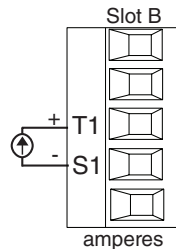
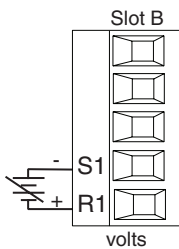

- 0 to 20 mA @ 100 Ω input impedance
- 0 to 10V= (dc) @ 20 kΩ input impedance
- 0 to 50 mV= (dc) @ 20 kΩ input impedance
- scalable

ST _ _ - _ _ _ _ - _ _ _ _ (all)



Warning:
Use National Electric (NEC) or other country-specific standard wiring and safety practices when wiring and connecting this controller to a power source and to electrical sensors or peripheral devices. Failure to do so may result in damage to equipment and property, and/or injury or loss of life.

NOTE: To prevent ground loops, isolation needs to be maintained from input to output when using switched DC or analog process outputs.

CAUTION: Always mount the controller with the heat-sink fins aligned vertically.

NOTE: Terminals L4 and A1 on the limit connector are jumpered at the factory to complete the contactor circuit. Additional switches may be wired in series to the terminals.



WARNING: If high voltage is applied to a low-voltage controller, irreversible damage will occur.

Input 2 Thermocouple

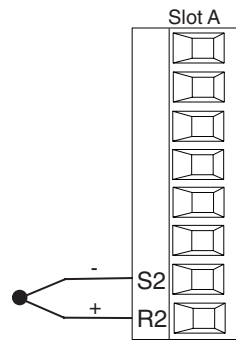

- 20 k Ω maximum source resistance
- >20 M Ω input impedance
- 3 microampere open-sensor detection
- Thermocouples are polarity sensitive. The negative lead (usually red) must be connected to S2.
- To reduce errors, the extension wire for thermocouples must be of the same alloy as the thermocouple.

ST_L - - - - - (limit)

Input 2 RTD

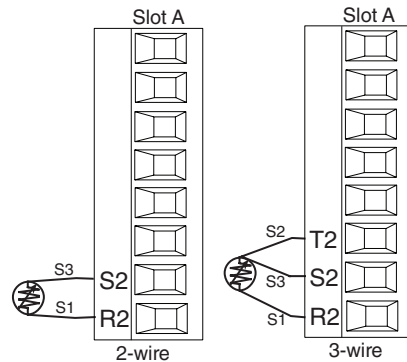

- platinum, 100 and 1,000 Ω @ 0°C
- calibration to DIN curve (0.00385 $\Omega/\Omega/^{\circ}\text{C}$)
- 20 Ω maximum lead resistance
- RTD excitation current of 0.09 mA typical. Each ohm of lead resistance may affect the reading by 0.03°C.
- For 3-wire RTDs, the S1 lead (usually white) must be connected to R2.
- For best accuracy use a 3-wire RTD to compensate for lead-length resistance. All three lead wires must have the same resistance.

ST_L - - - - - (limit)

Input 2 Process

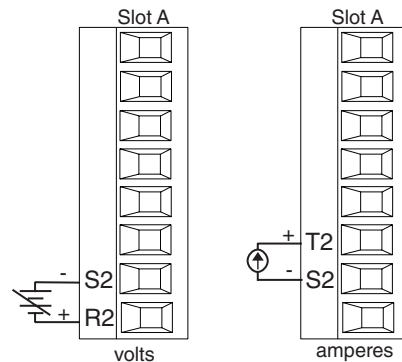

- 0 to 20 mA @ 100 Ω input impedance
- 0 to 10V $\overline{=}$ (dc) @ 20 k Ω input impedance
- 0 to 50 mV $\overline{=}$ (dc) @ 20 k Ω input impedance
- scalable

ST_L - - - - - (limit)



Warning:
 Use National Electric (NEC) or other country-specific standard wiring and safety practices when wiring and connecting this controller to a power source and to electrical sensors or peripheral devices. Failure to do so may result in damage to equipment and property, and/or injury or loss of life.

NOTE: To prevent ground loops, isolation needs to be maintained from input to output when using switched DC or analog process outputs.

CAUTION: Always mount the controller with the heat-sink fins aligned vertically.

NOTE: Terminals L4 and A1 on the limit connector are jumpered at the factory to complete the contactor circuit. Additional switches may be wired in series to the terminals.



WARNING: If high voltage is applied to a low-voltage controller, irreversible damage will occur.

Digital Input 5 - 6

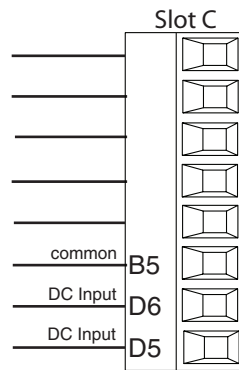

Digital Input

- Update rate 1 Hz
- Dry contact or dc voltage

DC Voltage

- Input not to exceed 36V at 3 mA
- Input active when > 3V @ 0.25 mA
- Input inactive when < 2V

Dry Contact

- Input inactive when > 500 Ω
- Input active when < 100 Ω
- maximum short circuit 13 mA

ST [B, C, D or E] _- - - - -
 - - - - -

Voltage Input

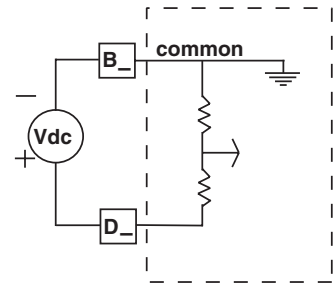

Dry Contact

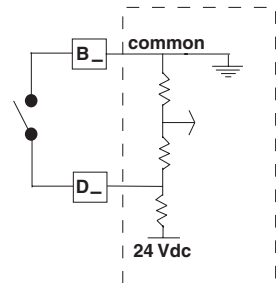



Warning:
Use National Electric (NEC) or other country-specific standard wiring and safety practices when wiring and connecting this controller to a power source and to electrical sensors or peripheral devices. Failure to do so may result in damage to equipment and property, and/or injury or loss of life.

NOTE: To prevent ground loops, isolation needs to be maintained from input to output when using switched DC or analog process outputs.

CAUTION: Always mount the controller with the heat-sink fins aligned vertically.

NOTE: Terminals L4 and A1 on the limit connector are jumpered at the factory to complete the contactor circuit. Additional switches may be wired in series to the terminals.



WARNING: If high voltage is applied to a low-voltage controller, irreversible damage will occur.

Quencharc Note:
Switching pilot duty inductive loads (relay coils, solenoids, etc.) with the mechanical relay, solid state relay or open collector output options requires use of an R.C. suppressor.

Output 1 Solid-State Relay with a Contactor

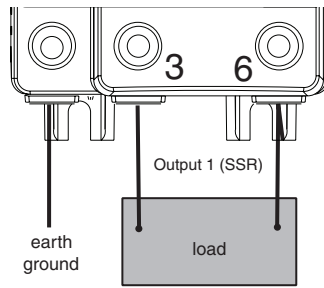

See Quencharc note.
ST ___ - B ___ - _____ (contactor)

Output 1 Solid-State Relay without a Contactor

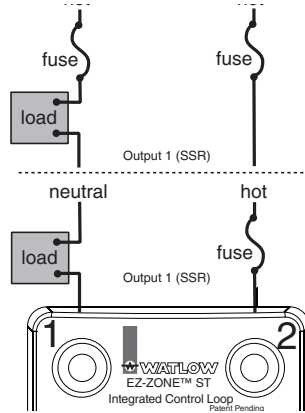

See Quencharc note.
ST ___ - A ___ - _____ (no contactor)

Solid-State Relay Derating Curve

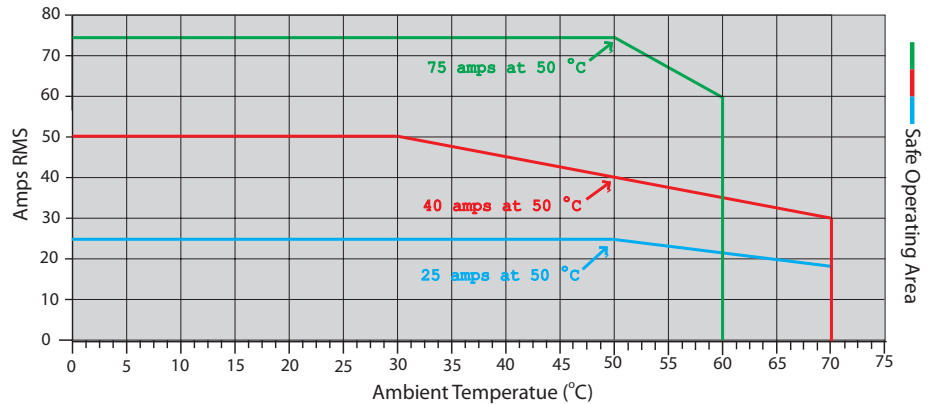



Warning:
Use National Electric (NEC) or other country-specific standard wiring and safety practices when wiring and connecting this controller to a power source and to electrical sensors or peripheral devices. Failure to do so may result in damage to equipment and property, and/or injury or loss of life.

NOTE: To prevent ground loops, isolation needs to be maintained from input to output when using switched DC or analog process outputs.

CAUTION: Always mount the controller with the heat-sink fins aligned vertically.

NOTE: Terminals L4 and A1 on the limit connector are jumpered at the factory to complete the contactor circuit. Additional switches may be wired in series to the terminals.



WARNING: If high voltage is applied to a low-voltage controller, irreversible damage will occur.

Quencharc Note:
Switching pilot duty inductive loads (relay coils, solenoids, etc.) with the mechanical relay, solid state relay or open collector output options requires use of an R.C. suppressor.

Output 2 Mechanical Relay, Form A

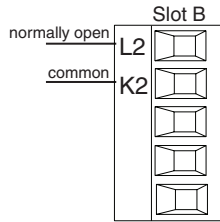

- 5 A at 240V~ (ac) or 30V= (dc) maximum resistive load
 - 20 mV at 24V minimum load
 - 125 VA pilot duty @ 120/240V~ (ac), 25 VA at 24V~ (ac)
 - 100,000 cycles at rated load
 - Output does not supply power.
 - for use with ac or dc
- See Quencharc note.
ST (H, D, J, C) _ - - - - -

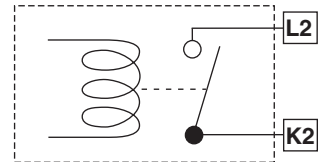

Output 2 Solid-State Relay, Form A

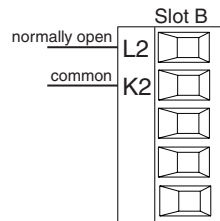

- 0.5 A at 20 to 264V~ (ac) maximum resistive load
 - 20 VA 120/240V~ (ac) pilot duty
 - opto-isolated, without contact suppression
 - maximum off state leakage of 105 microamperes
 - Output does not supply power.
 - Do not use on dc loads.
- See Quencharc note.
ST (K, B, P, E) _ - - - - -

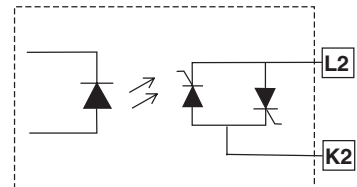

Output 3 Mechanical Relay, Form C

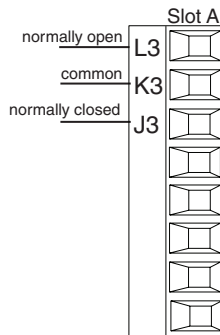

- 5 A at 240V~ (ac) or 30V= (dc) maximum resistive load
 - 20 mA at 24V minimum load
 - 125 VA pilot duty at 120/240V~ (ac), 25 VA at 24V~ (ac)
 - 100,000 cycles at rated load
 - Output does not supply power.
 - for use with ac or dc
- See Quencharc note.
ST _ L - - - - - (limit)

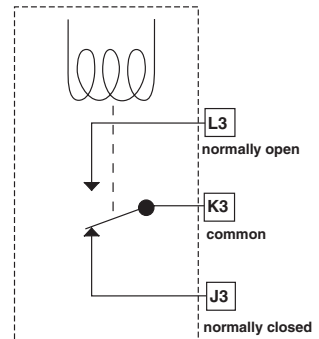

Output 4 Mechanical Relay, Form A

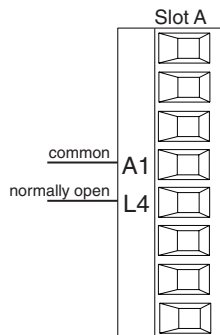

- 2 A at 240V~ (ac) or 30V= (dc) maximum resistive load
 - 20 mV at 24V minimum load
 - 125 VA pilot duty at 120/240V~ (ac), 25 VA at 24V~ (ac)
 - 100,000 cycles at rated load
 - Output does not supply power.
 - for use with ac or dc
- See Quencharc note.
ST _ L - - - - - (limit)

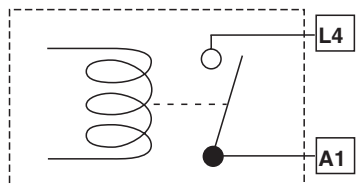



Warning:
Use National Electric (NEC) or other country-specific standard wiring and safety practices when wiring and connecting this controller to a power source and to electrical sensors or peripheral devices. Failure to do so may result in damage to equipment and property, and/or injury or loss of life.

NOTE: To prevent ground loops, isolation needs to be maintained from input to output when using switched DC or analog process outputs.

CAUTION: Always mount the controller with the heat-sink fins aligned vertically.

NOTE: Terminals L4 and A1 on the limit connector are jumpered at the factory to complete the contactor circuit. Additional switches may be wired in series to the terminals.



WARNING: If high voltage is applied to a low-voltage controller, irreversible damage will occur.

Quencharc Note:
Switching pilot duty inductive loads (relay coils, solenoids, etc.) with the mechanical relay, solid state relay or open collector output options requires use of an R.C. suppressor.

Digital Output 5 - 6

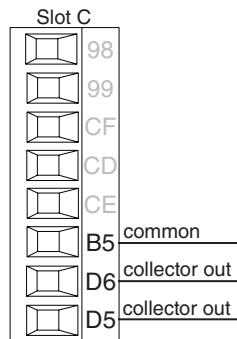

- Internal supply provides a constant power output of 750mW
- Maximum output sink current per output is 1.5A (external class 2 or SELV supply required)
- Total sink current for all outputs not to exceed 8A
- Do not connect outputs in parallel

ST [B, C, D or E] _ _ _
_ _ _ _ _

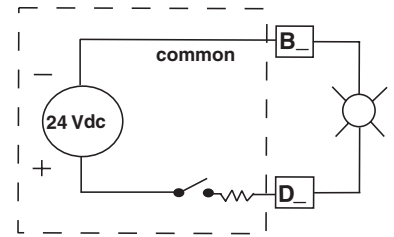

Quencharc Wiring Example

In this example the Quencharc circuit (Watlow part# 0804-0147-0000) is used to protect ST internal circuitry from the counter electromagnetic force from the inductive user load when de-energized. It is recommended that this or an equivalent Quencharc be used when connecting inductive loads to ST outputs.

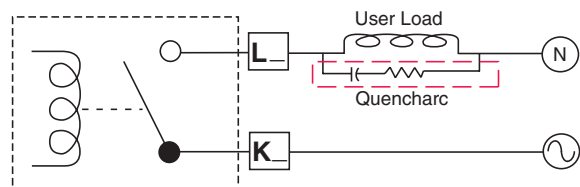



Warning:
Use National Electric (NEC) or other country-specific standard wiring and safety practices when wiring and connecting this controller to a power source and to electrical sensors or peripheral devices. Failure to do so may result in damage to equipment and property, and/or injury or loss of life.

NOTE: To prevent ground loops, isolation needs to be maintained from input to output when using switched DC or analog process outputs.

CAUTION: Always mount the controller with the heat-sink fins aligned vertically.

NOTE: Terminals L4 and A1 on the limit connector are jumpered at the factory to complete the contactor circuit. Additional switches may be wired in series to the terminals.



WARNING: If high voltage is applied to a low-voltage controller, irreversible damage will occur.

Note: Excessive writes to EEPROM over Modbus can cause premature EEPROM failure. The EEPROM is rated for 1,000,000 writes. See "Saving Settings to Nonvolatile Memory" in Chapter 2, Install and Wire.

Standard Bus EIA-485 Communications

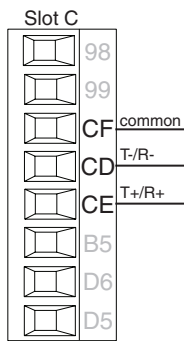

- Wire T-/R- to the A terminal of the EIA-485 port.
- Wire T+/R+ to the B terminal of the EIA-485 port.
- Wire common to the common terminal of the EIA-485 port.
- Do not route network wires with power wires. Connect network wires in daisy-chain fashion when connecting multiple devices in a network.

- Do not connect more than 16 controllers on a network.
 - maximum network length: 1,200 meters (4,000 feet)
 - 1/8th unit load on EIA-485 bus
- ST _ _ _ _ * _ _ _ _ _

* All models include Standard Bus communications

Modbus RTU or Standard Bus EIA-485 Communications

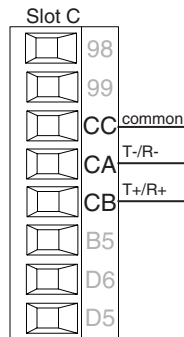

- Wire T-/R- to the A terminal of the EIA-485 port.
- Wire T+/R+ to the B terminal of the EIA-485 port.
- Wire common to the common terminal of the EIA-485 port.
- Do not route network wires with power wires. Connect network wires in daisy-chain fashion when connecting multiple devices in a network.
- A termination resistor may be required. Place a 120 Ω resistor across T+/R+ and T-/R- of last controller on network.

- Only one protocol per port is available at a time: either Modbus RTU or Standard Bus.
 - Do not connect more than 16 controllers on a Standard Bus network.
 - Do not connect more than 247 controllers on a Modbus RTU network.
 - maximum network length: 1,200 meters (4,000 feet)
 - 1/8th unit load on EIA-485 bus
- ST _ _ _ _ M _ _ _ _ _ (Modbus RTU or EIA-485)

Modbus-IDA Terminal	EIA/TIA-485 Name	Watlow Terminal Label	Function
DO	A	CA or CD	T-/R-
D1	B	CB or CE	T+/R+
common	common	CC or CF	common



Warning:
Use National Electric (NEC) or other country-specific standard wiring and safety practices when wiring and connecting this controller to a power source and to electrical sensors or peripheral devices. Failure to do so may result in damage to equipment and property, and/or injury or loss of life.

NOTE: To prevent ground loops, isolation needs to be maintained from input to output when using switched DC or analog process outputs.

CAUTION: Always mount the controller with the heat-sink fins aligned vertically.

NOTE: Terminals L4 and A1 on the limit connector are jumpered at the factory to complete the contactor circuit. Additional switches may be wired in series to the terminals.



WARNING: If high voltage is applied to a low-voltage controller, irreversible damage will occur.

Note: Excessive writes to EEPROM over Modbus can cause premature EEPROM failure. The EEPROM is rated for 1,000,000 writes. See "Saving Settings to Nonvolatile Memory" in Chapter 2, Install and Wire.

Wiring a Serial EIA-485 Network

Do not route network wires with power wires. Connect network wires in daisy-chain fashion when connecting multiple devices in a network.

A termination resistor may be required. Place a 120 Ω resistor across

T+/R+ and T-/R- of the last controller on a network.

Only one protocol per port is available at a time: either Modbus RTU or Standard Bus.

Note:

Do not route network wires with power wires.

A network using Watlow's Standard Bus and an RUI/Gateway.

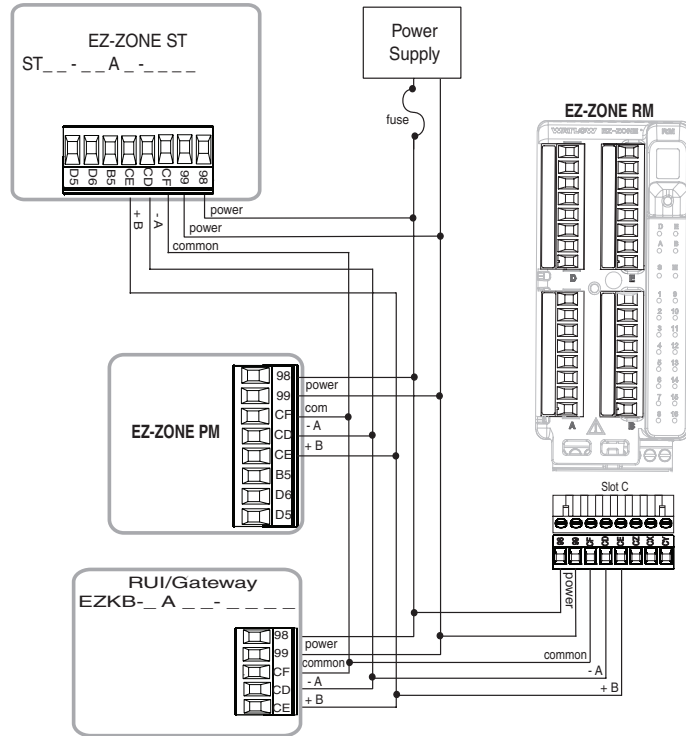

A network with all devices configured using Modbus RTU.

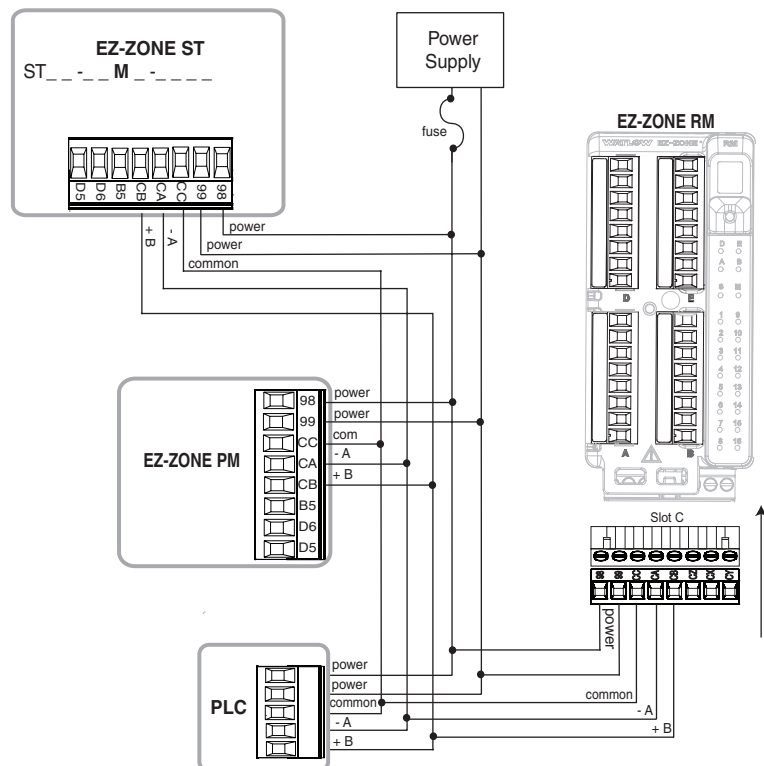

Setting the Address

Modbus Controller Address

The address of an EZ-ZONE® ST controller with the Modbus option (ST _ _ _ M _ _ _ _) can be set to ranges from 1 to 8 using the DIP switch and ranges 1 to 247 using software.

Set switch 4 to on to use Modbus communications. Modbus™ RTU addresses from 1 to 247 can be programmed into the controller using Standard bus communications. Only one controller can be connected to the network while changing the address using communications. After the Modbus address is changed, all four DIP switches must be turned on (set to 8) and the controller restarted for the new address to become available on the Modbus network. The Modbus addresses set by software will override only address 8, but lower addresses set on the DIP switch will override the software-assigned addresses.

As many as 247 controllers can be connected to a network.

The Standard bus address of an EZ-ZONE ST controller with the Modbus™ RTU option (ST _ _ _ M _ _ _ _) ranges from 1 to 8, because DIP switch 4 is reserved for switching Modbus on or off.

Zone	DIP Switch			
	1	2	3	**4
1	off	off	off	on
2	on	off	off	on
3	off	on	off	on
4	on	on	off	on
5	off	off	on	on
6	on	off	on	on
7	off	on	on	on
**8	on	on	on	on
**1 to 247	on	on	on	on

**** Set switch 4 to on to use Modbus communications. Modbus addresses from 1 to 247 can be programmed into the controller using Standard bus communications when switch 4 is off. After the Modbus address is changed, all four DIP switches must be turned on (set to 8) for the new address to become available on the Modbus network.**

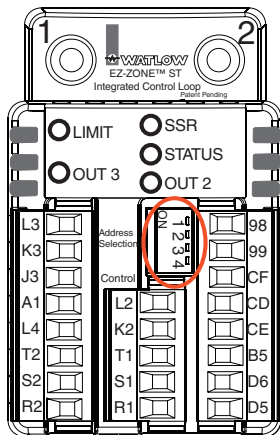

Communications Parameter Name	Range	Modbus (less 400,001 offset)	Data Type & Read/Write
Address (when all four DIP switches are set to on)	* 1 to 247	Map 1 313 Map 2 2052	uint RW
Baud	* 9,600 (188) 19,200 (189) 38,400 (190)	Map 1 314 Map 2 2054	uint RWE
Parity	Even (191) Odd (192) * None (61)	Map 1 315 Map 2 2056	uint RWE
Word Order	* Lowhigh (1331) Highlow (1330)	Map 1 - - - - Map 2 2058	uint RWE
Non-Volatile Save (ST Firmware 2 and higher)	* Yes (106) No (59)	Map 1 317 Map 2 2084	uint RWE
* Defaults			

Note:

Changing the Modbus parameters listed above must be done over Modbus using ST firmware release 2.0 and earlier. For firmware release 3.0 and above using either an RUI or EZ-ZONE Configurator software, navigate to the Setup Page and then to the Com [CORN] (RUI representation) menu to change.

CAUTION:

Changes set over Modbus are immediate. Users will not be able to communicate with the controller after its address, parity or baud rate has been changed. The master device will need to be re-configured to the new settings.

Saving Settings to Nonvolatile Memory

When controller settings are entered using the optional RUI, changes are always saved to Non-volatile Memory (EEPROM). If the controller loses power or is switched off, its settings will be restored when it starts again.

The EEPROM will wear out after about 1,000,000 writes, which would not be a problem with changes made from the RUI. However, if the controller is receiving changing instructions from a PLC or a computer through a network connection, the EEPROM could, over time, wear out. The Non-volatile Memory Save parameter allows the user to save settings made over the network to either volatile or non-volatile memory.

By default, settings made through the network are saved to non-volatile memory.

Note:

Changing Non-volatile Memory Save must be done over the network using ST firmware release 2.0 and earlier. For firmware release 3.0 and above using either an RUI or EZ-ZONE Configurator software, navigate to the Setup Page and then to the Com [CORN] (RUI representation) menu to change.

Watlow Standard Bus Controller Address

The address of an EZ-ZONE ST controller using Standard Bus exclusively (ST__ - __A _ - ____) ranges from 1 to 16, where up to 16 controllers can be connected on the Standard Bus network.

Zone	DIP Switch			
	1	2	3	*4
1	off	off	off	off
2	on	off	off	off
3	off	on	off	off
4	on	on	off	off
5	off	off	on	off
6	on	off	on	off
7	off	on	on	off
8	on	on	on	off
*9	off	off	off	on
*10	on	off	off	on
*11	off	on	off	on
*12	on	on	off	on
*13	off	off	on	on
*14	on	off	on	on
*15	off	on	on	on
*16	on	on	on	on

Conventions Used in the Menu Pages

To better understand the menu pages that follow review the naming conventions used. When encountered throughout this document, the word "default" implies as shipped from the factory. Each page (Operations, Setup, Profile and Factory) and their associated menus have identical headers defined below:

Header Name	Definition
Display	Visually displayed information from the control.
Parameter Name	Describes the function of the given parameter.
Range	Defines options available for this prompt, i.e., min/max values (numerical), yes/no, etc... (further explanation below).
Default	Values as delivered from the factory.
Modbus Relative Address	Identifies unique addresses when using either the Modbus RTU or Modbus TCP protocols (further explanation below).
CIP (Common Industrial Protocol)	Identifies unique parameters using either the DeviceNet or EtherNet/IP protocol (further explanation below).



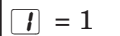
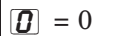
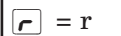
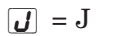
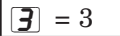
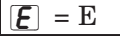
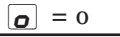
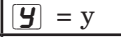
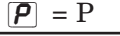
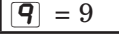
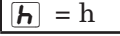

Header Name	Definition
Profibus Index	Identifies unique parameters using Profibus DP protocol (further explanation below).
Parameter ID	Identifies unique parameters used with other software such as, LabVIEW.
RUI/GTW Modbus	Identifies unique relative Modbus (RTU or TCP) addresses when using the Remote User Interface / Gateway.
Data Type R/W	uint = Unsigned 16 bit integer dint = Signed 32-bit, long string = ASCII (8 bits per character) float = IEEE 754 32-bit RWES = R eadable W ritable E EPROM (saved) U ser Set (saved)

If Using Optional RUI (Display)

Visual information from the control is displayed to the observer using a fairly standard 7 segment display. Due to the use of this technology, several characters displayed need some interpretation, see the list below:

 = 1	 = 0	 = i	 = r
 = 2	 = A	 = J	 = S
 = 3	 = b	 = K	 = t
 = 4	 = c	 = L	 = u
 = 5	 = d	 = M	 = v
 = 6	 = E	 = n	 = W
 = 7	 = F	 = o	 = y
 = 8	 = g	 = P	 = Z
 = 9	 = h	 = q	

Range

Within this column notice that on occasion there will be numbers found within parenthesis. This number represents the enumerated value for that particular selection. Range selections can be made simply by writing the enumerated value of choice using any of the available communications protocols. As an example, turn to the Setup Page and look at the Analog Input  menu and then the Sensor Type    prompt (instance 1). To turn the sensor off using Modbus simply write the value of 62 (off) to register 400043 (Map 1) or register 400369 (Map 2) and send

that value to the control.

Communication Protocols

All EZ-ZONE ST controllers come standard with the Standard Bus protocol. As an option it can also be delivered with the Modbus protocol as well. The Standard Bus protocol is used primarily for communications to other EZ-ZONE products to include the RUI and EZ-ZONE Configurator software (free download from Watlow's web site (<http://www.watlow.com>)). Other protocols that can be used to communicate with the ST are available when used in conjunction with the optional Remote User Interface/Gateway (RUIGTW).

- Modbus RTU 232/485
- EtherNet/IP, Modbus TCP
- DeviceNet
- Profibus DP

If interested in learning more about the RUI/GTW download the RUI/Gateway User Manual by pointing your browser to:

http://www.watlow.com/literature/pti_search.cfm?dltype=5

Once there move to the bottom of the page and enter EZ-ZONE into the Keyword field and then click the search button.

Modbus RTU & Modbus TCP Protocols

All Modbus registers are 16-bits and as displayed in this manual are relative addresses (actual). Some legacy software packages limit available Modbus registers to 40001 to 49999 (5 digits). Many applications today require access to all available Modbus registers which range from 400001 to 465536 (6 digits). Watlow controls support 6 digit Modbus registers. For parameters listed as float notice that only one (low order) of the two registers is listed, this is true throughout this document. By default the low order word contains the two low bytes of the 32-bit parameter. As an example, look in the Operations Page for the Process Value. Find the column identified in the header as Modbus and notice that it lists register 19 (instance 1, Map 1) and register 360 (instance 1, Map 2). Because this parameter is a float instance 1 Map 1 is actually represented by registers 19 (low order bytes) and 20 (high order bytes), likewise, instance 1 Map 2 is actually represented by registers 360 (low order bytes) and 361 (high order bytes). Because the Modbus specification does not dictate which register should be high or low order Watlow provides the user the ability to swap this order (Setup Page, **[CONF]** Menu) from the default low/high **[LoHi]** to high/low **[HiLo]**.

Note:

With the release of firmware revision 3.00 and above new capabilities (phase angle control, user programmable memory blocks, etc...) were introduced into this product line. With the introduction of these new capabilities there was a repacking of Modbus registers. Notice in the column identified as Modbus the reference to Map 1 and Map 2 reg-

isters for each of the various parameters. If the new capabilities are to be used, be certain to select Map 2 Modbus registers. If the new functions of this product line are not to be used, Map 1 (legacy ST controls) Modbus registers will be sufficient. The Modbus register mapping **[PARR]** can be changed in the Setup Page under the **[CONF]** Menu. This setting will apply across the control.

It should also be noted that some of the cells in the Modbus column as well as the RUI/GTW Modbus column contain wording pertaining to an offset. Several parameters in the control contain more than one instance; such as, profiles (4), alarms (2), analog inputs (2), etc... The Modbus register shown always represents instance one. Take for an example the Step Type **[STEP]** parameter found in the Profile Page. Instance one, Map 1, is shown as address 500 and +20 is identified as the offset to the next instance. If there was a desire to read or write to instance 3 simply add 40 to 500 to find its address. In this case, the instance 3 address for Step Type is 540.

The ST control, when equipped with Modbus has user programmable memory blocks. To learn more about this feature click on the link or turn to the Features section and look for the section entitled "**Modbus - User Programmable Memory Blocks**".

Data Types Used with Modbus

unsigned	= Unsigned 16 bit integer
signed	= Signed 16-bit
float	= Float, IEEE 754 32-bit
long	= 32 bit unsigned integer
sint	= Signed 8 bits , byte

To learn more about the Modbus protocol point your browser to <http://www.modbus.org>.

Common Industrial Protocol (CIP) DeviceNet & Ethernet/IP

Both DeviceNet and EtherNet/IP use open object based programming tools and use the same addressing scheme. In the following menu pages notice the column header identified as CIP. There you will find the Class, Instance and Attribute in hexadecimal, (decimal in parenthesis) which makes up the addressing for both protocols.

The ST control has a feature that allows for implicit messaging when used in conjunction with an RUI/GTW equipped with a DeviceNet or EtherNet/IP card. To learn more about this feature click on the link or turn to the Features section and look for the section entitled "**CIP - Communications Capabilities**".

Data Types Used with CIP

uint	= Unsigned 16 bit integer
int	= Signed 16-bit
dint	= Signed 32-bits, long
real	= Float, IEEE 754 32-bit
string	= ASCII, 8 bits per character
sint	= Signed 8 bits , byte

To learn more about the DeviceNet and EtherNet/IP protocol point your browser to <http://www.odva.org>.

Profibus DP

To accommodate for Profibus DP addressing the following menus contain a column identified as Profibus Index. Data types used in conjunction with Profibus DP can be found in the table below. For more information pertaining to the use of this protocol with the ST control download the RUI/Gateway User Manual by pointing your browser to:

http://www.watlow.com/literature/pti_search.cfm?dltype=5

Once there move to the bottom of the page and enter EZ-ZONE into the Keyword field and then click the search button.

Data Types Used with Profibus DP



Word	= Unsigned 16 bit
INT	= Signed 16-bit Integer
dint	= Signed 32-bit Integer
REAL	= Float, IEEE 754 32-bit
CHAR	= ASCII, 8 bits per character
BYTE	= 8 bits



To learn more about the Profibus DP protocol point your browser to <http://www.profibus.org>

3





Chapter 3: Operations Pages

Control Module Operation Page Parameters

To go to the Operations Page from the Home Page, press both the Up  and Down  keys for three seconds. **A** will appear in the upper display and **OPER** will appear in the lower display.

- Press the Up  or Down  key to view available menus. On the following pages top level menus are identified with a yellow background color.
- Press the Advance Key  to enter the menu of choice.
- If a submenu exists (more than one instance),

press the Up  or Down  key to select and then press the Advance Key  to enter.

- Press the Up  or Down  key to move through available menu prompts.
- Press the Infinity Key  to move backwards through the levels: parameter to submenu; submenu to menu; menu to Home Page.
- Press and hold the Infinity Key  for two seconds to return to the Home Page.

A
OPER Analog Input Menu
I
A Analog Input 1
A_{IN} Process Value
E_R Error Status
C_R Calibration Offset

d_{IO}
OPER Digital Input/Output Menu
I
d_{IO} Digital Input/Output 1
d_{OS} Output State
d_{IS} Event State

L_{LN}
OPER Limit Menu
I
L_{LN} Limit 1
L_{LS} Low Set Point
L_{HS} High Set Point

M_{ON}
OPER Monitor Menu
I
M_{ON} Monitor 1
C_{MA} Control Mode Active
H_{PR} Heat Power
C_{PR} Cool Power
C_{SP} Closed Loop Working Set Point
P_{VA} Process Value Active

L_{OP}
OPER Loop Menu
I
L_{OP} Loop 1
C_{LN} Control Mode
A_{ESP} Autotune Set Point
A_{UR} Autotune Request
C_{SP} Closed Loop Set Point
I_{SP} Idle Set Point
H_{PB} Heat Proportional Band
H_{HY} Heat Hysteresis
C_{PB} Cool Proportional Band

C_{HY} Cool Hysteresis
E_I Time Integral
E_D Time Derivative
DB Dead Band
O_{SP} Open Loop Set Point

AL_{LN}
OPER Alarm Menu
I
AL_{LN} Alarm 1
A_{LO} Low Set Point
A_{HI} High Set Point

C_{UR}
OPER Current Menu
I
C_{UR} Current 1
C_{HI} High Set Point
C_{LO} Low Set Point
C_{UR} Read
C_{ER} Error
H_{ER} Heater Error

P_{STA}
OPER Profile Status Menu
I
P_{STA} Profile Status 1
P_{ST} Profile Start
P_{AR} Action Request
S_{EP} Active Step
S_{ETP} Active Step Type
T_{SP1} Target Set Point Loop 1
P_{SP1} Produced Set Point 1
H_{OUR} Hours Remaining
M_{IN} Minutes Remaining
S_{EC} Seconds Remaining
E_{NT1} Active Event Output 1
E_{NT2} Active Event Output 2
J_C Jump Count Remaining

Operations Page

Display	Parameter Name Description	Range	Default	Modbus Relative Ad- dress	CIP Class Instance Attribute hex (dec)	Pro DP Index	Par ID	RUI/ GTW Mod- bus	Data Type & Read/ Write
<div style="border: 1px solid black; padding: 2px;"> A i oPEr Analog Input Menu </div>									
A i n [Ain]	<i>Analog Input (1 to 2)</i> Process Value View the process value.	-1,999.000 to 9,999.000°F or units -1,128.000 to 5,537.000°C		Instance 1 Map 1 Map 2 ---- 360 Instance 2 Map 1 Map 2 ---- 450-	0x68 (104) 1 to 2 1	0	4001	Inst. 1 360 Inst. 2 520	float R
No Dis- play	<i>Analog Input (1 to 2)</i> Filtered Process Value View the filtered process value.	-1,999.000 to 9,999.000°F or units -1,128.000 to 5,537.000°C		Instance 1 Map 1 Map 2 ---- 402 Instance 2 Map 1 Map 2 ---- 492-	0x68 (104) 1 to 2 0x16 (22)	0	4022	Inst. 1 402 Inst. 2 562	float R
No Dis- play	<i>Analog Input (1)</i> Ambient Temperature View ambient temperature.	-1,999.000 to 9,999.000°F or units -1,128.000 to 5,537.000°C		Instance 1 Map 1 Map 2 34 366 Instance 2 Map 1 Map 2 ---- 492-	0x68 (104) 1 4	0	4004	Inst. 1 402 Inst. 2 562	float R
.iEr [i.Er]	<i>Analog Input (1 to 2)</i> Error Status View the cause of the most recent error. If the REEn message is Er.i1 or Er.i2 , this parameter will display the cause of the input error.	nonE None (61) OPEn Open (65) ShrE Shorted (127) Er.i1 Measurement Er- ror (149) Er.i2 Bad Calibration Data (139) Er.AB Ambient Error (9) Er.Ed RTD Error (141) FR.iL Fail (32) NSrc Not Sourced (146)	None	Instance 1 Map 1 Map 2 41 362 Instance 2 Map 1 Map 2 69 452	0x68 (104) 1 to 2 2	1	4002	Inst. 1 362 Inst. 2 522	uint R
No Dis- play	<i>Analog Input (1)</i> Clear Latched Input Er- ror Clear latched input.	Clear (0) No Change (255)		Instance 1 Map 1 Map 2 68 416 Instance 2 Map 1 Map 2 96 506	0x68 (104) 1 0x1D (29)	0	4029	Inst. 1 416	uint W
.iCR [i.CA]	<i>Analog Input (1 to 2)</i> Calibration Offset Offset the input reading to compensate for lead wire resistance or other factors that cause the input reading to vary from the actual process value.	-1,999.000 to 9,999.000°F or units -1,110.555 to 5,555.000°C	0.0	Instance 1 Map 1 Map 2 51 382 Instance 2 Map 1 Map 2 79 472	0x68 (104) 1 to 2 0xC (12)	2	4012	Inst. 1 382 Inst. 2 542	float RWES
Note: Some values will be rounded off to fit in the four-character display. Full values can be read with other interfaces. If there is only one instance of a menu, no submenus will appear.									R: Read W: Write E: EE- PROM S: User Set

Operations Page

Display	Parameter Name Description	Range	Default	Modbus Relative Ad- dress	CIP Class Instance Attribute hex (dec)	Pro DP Index	Par ID	RUI/ GTW Mod- bus	Data Type & Read/ Write
do oPEr Digital Input/Output Menu									
do.S [do.S]	Digital Output (5 to 6) Output State View the state of this out- put.	oFF Off (62) on On (63)		Instance 1 Map 1 Map 2 175 1072 Instance 2 Map 1 Map 2 188 1102	0x6A (106) 5 to 6 7	90	6007	Inst. 5 1012 Inst. 6 1042	uint R
Ei.S [Ei.S]	Digital Input (5 to 6) Event Status View this event input state.	oFF Off (62) on On (63)		Instance 1 Map 1 Map 2 32 1298 Instance 2 Map 1 Map 2 33 1318	0x6E (110) 1 to 2 5	140	10005	Inst. 1 1408 Inst. 2 1428	uint R
Li.PP oPEr Limit Menu									
LL.S [LL.S]	Limit (1) Low Set Point Set the low process value that will trigger the limit.	-1,999.000 to 9,999.000°F or units -1,128.000 to 5,537.000°C	0.0°F or units -18.0°C	Instance 1 Map 1 Map 2 275 724	0x70 (112) 1 3	38	12003	Inst. 1 684	float RWES
Lh.S [Lh.S]	Limit (1) High Set Point Set the high process value that will trigger the limit.	-1,999.000 to 9,999.000°F or units -1,128.000 to 5,537.000°C	0.0°F or units -18.0°C	Instance 1 Map 1 Map 2 277 726	0x70 (112) 1 4	39	12004	Inst. 1 686	float RWES
LEI [L.St1]	Limit (1) Limit Status Clear limit once limit con- dition is cleared.	Safe (1667) Fail (32)	----	Instance 1 Map 1 Map 2 ---- 744	----	----	----	Inst. 1 ----	uint R
No Dis- play	Limit (1) Output Value Current state of limit out- put.	Off (62) On (63)	----	Instance 1 Map 1 Map 2 ---- 732	0x70 (112) 1 7	----	----	Inst. 1 ----	uint R
No Dis- play	Limit (1) Limit State Clear limit once limit con- dition is cleared.	Off (62) None (61) Limit High (51) Limit Low (52) Error (225)	----	Instance 1 Map 1 Map 2 280 730	0x70 (112) 1 6	----	12006	Inst. 1 690	uint R
No Dis- play	Limit (1) Limit Clear Request Clear limit once limit con- dition is cleared.	Clear (0) No Change (255)	----	Instance 1 Map 1 Map 2 272 720	0x70 (112) 1 1	----	12001	Inst. 1 680	uint W
PPon oPEr Monitor Menu									
CPMA [C.MA]	Monitor (1) Control Mode Active View the current control mode.	oFF Off (62) RUEo Auto (10) PPAn Manual (54)		Instance 1 Map 1 Map 2 222 1752	0x97 (151) 1 2	----	8002	Inst. 1 1880	uint R
Note: Some values will be rounded off to fit in the four-character display. Full values can be read with other interfaces.									R: Read W: Write E: EE- PROM S: User Set
If there is only one instance of a menu, no submenus will appear.									

Operations Page

Display	Parameter Name Description	Range	Default	Modbus Relative Ad- dress	CIP Class Instance Attribute hex (dec)	Pro DP Index	Par ID	RUI/ GTW Mod- bus	Data Type & Read/ Write
<input type="checkbox"/> h.Pr [h.Pr]	<i>Monitor (1)</i> Heat Power View the current heat out- put level.	0.0 to 100.0%	0.0	Instance 1 <i>Map 1 Map 2</i> 236 1774	0x97 (151) 1 0xD (13)	----	8011	Inst. 1 1900	float R
<input type="checkbox"/> C.Pr [C.Pr]	<i>Monitor (1)</i> Cool Power View the current cool out- put level.	-100.0 to 0.0%	0.0	Instance 1 <i>Map 1 Map 2</i> 242 1776	0x97 (151) 1 0xE (14)	----	8014	Inst. 1 1906	float R
<input type="checkbox"/> C.SP [C.SP]	<i>Monitor (1)</i> Closed Loop Working Set Point View the set point currently in effect.	-1,999.000 to 9,999.000°F or units -1,128.000 to 5,537.000°C		Instance 1 <i>Map 1 Map 2</i> -----	0x97 (108) 1 0x1D (29)	----	8029	Inst. 1 1936	float R
<input type="checkbox"/> P.v.A [Pv.A]	<i>Monitor (1)</i> Process Value Active View the active process value.	-1,999.000 to 9,999.000°F or units -1,128.000 to 5,537.000°C		Instance 1 <i>Map 1 Map 2</i> 19 ----	0x97 (108) 1 0x1F (31)	----	8031	Inst. 1 1940	float R
No Dis- play	<i>Monitor (1)</i> Set Point Active Read the current active set point.	-1,999.000 to 9,999.000°F or units -1,128.000 to 5,537.000°C		Instance 1 <i>Map 1 Map 2</i> 2172 2652 Instance 2 <i>Map 1 Map 2</i> 2252 2732	0x6B (107) 1 7	----	7018	Inst. 1 2172	float R
Loop oPer Loop Menu									
<input type="checkbox"/> C.M [C.M]	<i>Control Loop (1)</i> Control Mode Select the method that this loop will use to control.	<input type="checkbox"/> oFF Off (62) <input type="checkbox"/> Auto Auto (10) <input type="checkbox"/> Man Manual (54)	Auto	Instance 1 <i>Map 1 Map 2</i> 221 1750	0x97 (151) 1 1	63	8001	Inst. 1 1880	uint RWES
<input type="checkbox"/> A.t.SP [A.t.SP]	<i>Control Loop (1)</i> Autotune Set Point Set the set point that the autotune will use, as a percentage of the current set point.	50.0 to 200.0%	90.0	Instance 1 <i>Map 1 Map 2</i> 260 1788	0x97 (151) 1 0x14 (20)	----	8025	Inst. 1 1928	float RWES
<input type="checkbox"/> AUt [AUt]	<i>Control Loop (1)</i> Autotune Request Start an autotune. While the autotune is active, the Home Page will display Autn Run . When the autotune is complete, the message will clear automatically.	<input type="checkbox"/> no No <input type="checkbox"/> YES Yes	No	Instance 1 <i>Map 1 Map 2</i> 262 1790	0x97 (151) 1 0x15 (21)	64	8026	Inst. 1 1930	uint RW
<input type="checkbox"/> C.SP [C.SP]	<i>Control Loop (1)</i> Closed Loop Set Point Set the set point that the controller will automati- cally control to.	Low Set Point to High Set Point (Setup Page)	75.0°F or units 24.0°C	Instance 1 <i>Map 1 Map 2</i> 21 1890	0x6B (107) 1 1	49	7001	Inst. 1 1936	float RWES
<input type="checkbox"/> id.S [id.S]	<i>Control Loop (1)</i> Idle Set Point Set a closed loop set point that can be triggered by an event state.	Low Set Point to High Set Point (Setup Page)	75.0°F or units 24.0°C	Instance 1 <i>Map 1 Map 2</i> 207 1906	0x6B (107) 1 9	50	7009	Inst. 1 ----	float RWES
Note: Some values will be rounded off to fit in the four-character display. Full values can be read with other interfaces. If there is only one instance of a menu, no submenus will appear.									R: Read W: Write E: EE- PROM S: User Set

Operations Page

Display	Parameter Name Description	Range	Default	Modbus Relative Ad- dress	CIP Class Instance Attribute hex (dec)	Pro DP Index	Par ID	RUI/ GTW Mod- bus	Data Type & Read/ Write
<input type="checkbox"/> h.Pb [h.Pb]	<i>Control Loop (1)</i> Heat Proportional Band Set the PID proportional band for the heat outputs.	0.001 to 9,999.000°F or units -1,110.555 to 5,555.000°C	25.0°F or units 14.0°C	Instance 1 <i>Map 1 Map 2</i> 232 1760	0x97 (151) 1 6	65	8009	Inst. 1 1896	float RWES
<input type="checkbox"/> h.hy [h.hy]	<i>Control Loop (1)</i> Heat Hysteresis Set the control switching hysteresis for on-off control. This determines how far into the “on” region the process value needs to move before the output turns on.	0.001 to 9,999.000°F or units -1,110.555 to 5,555.000°C	3.0°F or units 2.0°C	Instance 1 <i>Map 1 Map 2</i> 234 1770	0x97 (151) 1 0xB (11)	66	8010	Inst. 1 1898	float RWES
<input type="checkbox"/> C.Pb [C.Pb]	<i>Control Loop (1)</i> Cool Proportional Band Set the PID proportional band for the cool outputs.	0.001 to 9,999.000°F or units -1,110.555 to 5,555.000°C	25.0°F or units 14.0°C	Instance 1 <i>Map 1 Map 2</i> 238 1762	0x97 (151) 1 7	67	8012	Inst. 1 1902	float RWES
<input type="checkbox"/> C.hy [C.hy]	<i>Control Loop (1)</i> Cool Hysteresis Set the control switching hysteresis for on-off control. This determines how far into the “on” region the process value needs to move before the output turns on.	0.001 to 9,999.000°F or units -1,110.555 to 5,555.000°C	3.0°F or units 2.0°C	Instance 1 <i>Map 1 Map 2</i> 240 1772	0x97 (151) 1 0xC (12)	68	8013	Inst. 1 1904	float RWES
<input type="checkbox"/> ti [ti]	<i>Control Loop (1)</i> Time Integral Set the PID integral for the outputs.	0 to 9,999 seconds per repeat	180.0 seconds per repeat	Instance 1 <i>Map 1 Map 2</i> 226 1764	0x97 (151) 1 8	69	8006	Inst. 1 1890	float RWES
<input type="checkbox"/> td [td]	<i>Control Loop (1)</i> Time Derivative Set the PID derivative time for the outputs.	0 to 9,999 seconds	0.0 seconds	Instance 1 <i>Map 1 Map 2</i> 228 1766	0x97 (151) 1 9	70	8007	Inst. 1 1892	float RWES
<input type="checkbox"/> db [db]	<i>Control Loop (1)</i> Dead Band Set the offset to the proportional band. With a negative value, both heating and cooling outputs are active when the process value is near the set point. A positive value keeps heating and cooling outputs from fighting each other.	-1,000.0 to 1,000.0°F or units -556 to 556°C	0.0	Instance 1 <i>Map 1 Map 2</i> 230 1768	0x97 (151) 1 0xA (10)	71	8008	Inst. 1 1894	float RWES
<input type="checkbox"/> o.SP [o.SP]	<i>Control Loop (1)</i> Open Loop Set Point Set a fixed level of output power when in manual (open-loop) mode.	-100 to 100% (heat and cool) 0 to 100% (heat only) -100 to 0% (cool only)	0.0	Instance 1 <i>Map 1 Map 2</i> 23 1892	0x6B (107) 1 2	51	7002	Inst. 1 ----	float RWES
No Display	<i>Control Loop (1)</i> Loop Error Open Loop detect deviation has been exceeded.	None (61) Open Loop (1274) Reversed Sensor (1275)	----	Instance 1 <i>Map 1 Map 2</i> ---- 1798	0x6C (108) 1 0x30 (48)	----	8048	Inst. 1 ----	uint R
No Display	<i>Control Loop (1)</i> Clear Loop Error Current state of limit output.	Clear (129) Ignore (204)	----	Instance 1 <i>Map 1 Map 2</i> ---- 1800	0x6C (108) 1 0x31 (49)	----	8049	Inst. 1 ----	uint W
Note: Some values will be rounded off to fit in the four-character display. Full values can be read with other interfaces. If there is only one instance of a menu, no submenus will appear.									R: Head W: Write E: EE- PROM S: User Set

Operations Page

Display	Parameter Name Description	Range	Default	Modbus Relative Ad- dress	CIP Class Instance Attribute hex (dec)	Pro DP Index	Par ID	RUI/ GTW Mod- bus	Data Type & Read/ Write
ALP OPER Alarm Menu									
<input type="checkbox"/> ALo [A.Lo]	Alarm (1 to 2) Low Set Point If Alarm Type (Setup Page, Alarm Menu) is set to: process - set the process value that will trigger a low alarm. deviation - set the span of units from the closed loop set point that will trigger a low alarm.	-1,999.000 to 9,999.000°F or units -1,128.000 to 5,537.000°C	32.0°F or units 0.0°C	Instance 1 Map 1 Map 2 99 1452 Instance 2 Map 1 Map 2 115 1512	0x6D (109) 1 to 2 2	18	9002	Inst. 1 1482 Inst. 2 1532	float RWES
<input type="checkbox"/> Ahi [A.hi]	Alarm (1 to 2) High Set Point If Alarm Type (Setup Page, Alarm Menu) is set to: process - set the process value that will trigger a high alarm. deviation - set the span of units from the closed loop set point that will trigger a high alarm.	-1,999.000 to 9,999.000°F or units -1,128.000 to 5,537.000°C	300.0°F or units 150.0°C	Instance 1 Map 1 Map 2 97 1450 Instance 2 Map 1 Map 2 113 1510	0x6D (109) 1 to 2 1	19	9001	Inst. 1 1480 Inst. 2 1530	float RWES
No Display	Alarm (1 to 2) Alarm State Read current state of alarm	Startup (88) None (61) Blocked (12) Alarm low (8) Alarm high (7) Error (28)	None	Instance 1 Map 1 Map 2 29 1466 Instance 2 Map 1 Map 2 30 1526	0x6D (109) 1 to 2 9	----	9009	Inst. 1 1496 Inst. 2 1546	uint R
No Display	Alarm (1 to 2) Alarm Clearable Indicates if alarm can be cleared.	<input type="checkbox"/> no No (59) <input checked="" type="checkbox"/> YES Yes (106)	None	Instance 1 Map 1 Map 2 ---- 1472 Instance 2 Map 1 Map 2 ---- 1532	0x6D (109) 1 to 2 0xC (12)	----	9012	Inst. 1 1502 Inst. 2 1552	uint R
No Display	Alarm (1 to 2) Alarm Clear Request Write to this register to clear an alarm	Clear (0) No Change (255)	None	Instance 1 Map 1 Map 2 108 1474 Instance 2 Map 1 Map 2 124 1534	0x6D (109) 1 to 2 0xD (13)	32	9013	Inst. 1 1504 Inst. 2 1554	uint W
No Display	Alarm (1 to 2) Alarm Silence Request Write to this register to silence an alarm	Clear (0) No Change (255)	None	Instance 1 Map 1 Map 2 109 1476 Instance 2 Map 1 Map 2 125 1536	0x6D (109) 1 to 2 0xE (14)	33	9014	Inst. 1 1506 Inst. 2 1556	uint W
Note: Some values will be rounded off to fit in the four-character display. Full values can be read with other interfaces. If there is only one instance of a menu, no submenus will appear.									R: Read W: Write E: EE- PROM S: User Set

Operations Page

Display	Parameter Name Description	Range	Default	Modbus Relative Ad- dress	CIP Class Instance Attribute hex (dec)	Pro DP Index	Par ID	RUI/ GTW Mod- bus	Data Type & Read/ Write
No Dis- play	<i>Alarm (1 to 2)</i> Alarm Silenced Indicates if alarm can be silenced.	Yes (106) No (59)	----	Instance 1 <i>Map 1 Map 2</i> 1500 1900 Instance 2 <i>Map 1 Map 2</i> 1550 1960	0x6D (109) 1 to 4 0x0B (11)	----	9011	Inst. 1 1500 Inst. 2 1550	uint R
No Dis- play	<i>Alarm (1 to 2)</i> Alarm Latched Indicates if alarm is latched.	Yes (106) No (59)	----	Instance 1 <i>Map 1 Map 2</i> 1498 1898 Instance 2 <i>Map 1 Map 2</i> 1548 1958	0x6D (109) 1 to 4 0x0A (10)	----	9010	Inst. 1 1498 Inst. 2 1548	uint R
[Curr] [oPEr] Current Menu				Note: To use the current sensing feature, Time Base (Setup Page, Output Menu) must be set to 0.7 seconds or more.					
[Ch] [C.hi]	<i>Current (1)</i> High Set Point Set the current value that will trigger a high heater error state.	-1,999.000 to 9,999.000	50.0	Instance 1 <i>Map 1 Map 2</i> 286 1254	0x73 (115) 1 8	----	15008	Inst. 1 1134	float RWES
[CLo] [C.Lo]	<i>Current (1)</i> Low Set Point Set the current value that will trigger a low heater error state.	-1,999.000 to 9,999.000	0.0	Instance 1 <i>Map 1 Map 2</i> 288 1256	0x73 (115) 1 9	----	15009	Inst. 1 1136	float RWES
[CUr] [CU.r]	<i>Current (1)</i> Read View the most recent current value monitored by the current transformer.	-1,999.000 to 9,999.000		Instance 1 <i>Map 1 Map 2</i> 38 1240	0x73 (115) 1 1	----	15001	Inst. 1 ----	float R
[CEr] [C.Er]	<i>Current (1)</i> SSR Error View the cause of the most recent load fault.	[nonE] None (61) [Shrt] Shorted (127) [oPEr] Open (65)	None	Instance 1 <i>Map 1 Map 2</i> 40 1242	0x73 (115) 1 2	----	15002	Inst. 1 1122	uint R
[hEr] [h.Er]	<i>Current (1)</i> Heater Error View the cause of the most recent load fault monitored by the current transformer.	[nonE] None (61) [h,gh] High (37) [LoLd] Low (53)	None	Instance 1 <i>Map 1 Map 2</i> 282 1244	0x73 (115) 1 3	----	15003	Inst. 1 1124	uint R
No Dis- play	<i>Current (1)</i> Error Status View the cause of the most recent load fault	[nonE] None (61) [FRIL] Fail (32)	----	Instance 1 <i>Map 1 Map 2</i> 1160 1400	0x73 (115) 1 21	----	15021	----	uint R
Note: Some values will be rounded off to fit in the four-character display. Full values can be read with other interfaces. If there is only one instance of a menu, no submenus will appear.									R: Read W: Write E: EE- PROM S: User Set

Operations Page

Display	Parameter Name Description	Range	Default	Modbus Relative Address	CIP Class Instance Attribute hex (dec)	Pro DP Index	Par ID	RUI/ GTW Modbus	Data Type & Read/ Write
PSER OPER Profile Status Menu		* Some parameters in the Profile Status Menu can be changed for the currently running profile, but should only be changed by knowledgeable personnel and with caution. Changing parameters via the Profile Status Menu will not change the stored profile but will have an immediate impact on the profile that is running. Changes made to profile parameters in the Profiling Pages will be saved and will also have an immediate impact on the running profile.							
PSER [P.Str]	Profile Status Profile Start	1 to 40	1	Instance 1 Map 1 Map 2 292 3800	0x7A (122) 1 1	204	22001	Inst. 1 2898 Offset + 80	uint RWE
PACr [PACr]	Profile Status Action Request	none None (61) ProF Profile (77) PAUS Pause (146) RESU Resume (147) End Terminate (148) STEP Step (89)	None	Instance 1 Map 1 Map 2 306 3820	0x7A (122) 1 0xB (11)	205	22011	Inst. 1 2920 Offset + 80	uint RW
STEP [StP]	Profile Status Active Step View the currently running step.	1 to 40	0 (none)	Instance 1 Map 1 Map 2 296 3806	0x7A (122) 1 4	----	22004	Inst. 1 2906 Offset + 80	uint R
STEP [S.typ]	Profile Status Active Step Type View the currently running step type.	USEP Unused Step (50) Time (143) RATE Rate (81) Soak Soak (87) WJE Wait for Event (144) WJPr Wait for Process(209) CLoC Wait for Time (1543) JL Jump Loop (116) End End (27)	----	Instance 1 Map 1 Map 2 ---- 3824	0x7A (122) 1 0xD (13)	----	22013	Inst. 1 2924 Offset + 80	uint R
ESP1 [tg.SP]	Profile Status *Target Set Point Loop 1 View or change the target set point of the current step.	-1,999.000 to 9,999.000°F or units -1,128.000 to 5,537.000°C	0.0°F or units -18.0°C	Instance 1 Map 1 Map 2 ---- 3822	0x7A (122) 1 0xC (12)	----	22012	----	uint RW
PSP1 [P.SP1]	Profile Status Produced Set Point 1 Display the current set point, even if the profile is ramping.	-1,999.000 to 9,999.000°F or units -1,128.000 to 5,537.000°C	0.0°F or units -18.0°C	Instance 1 Map 1 Map 2 297 3808	----	----	22005	Inst. 1 2908 Offset + 80	float R
hour [hour]	Profile Status Hours Remaining	0 to 99	0.0	Instance 1 Map 1 Map 2 ---- ----	----	----	22078	----	----
min [Min]	Profile Status Minutes Remaining	0 to 59	0.0	Instance 1 Map 1 Map 2 ---- ----	----	----	22077	----	----
Note: Some values will be rounded off to fit in the four-character display. Full values can be read with other interfaces. If there is only one instance of a menu, no submenus will appear.									R: Read W: Write E: EE-PROM S: User Set

Operations Page

Display	Parameter Name Description	Range	Default	Modbus Relative Ad- dress	CIP Class Instance Attribute hex (dec)	Pro DP Index	Par ID	RUI/ GTW Mod- bus	Data Type & Read/ Write
SEc [Sec]	<i>Profile Status</i> Seconds Remaining	0 to 59	0.0	Instance 1 Map 1 Map 2 -----	-----	-----	22076	-----	-----
No Dis- play	<i>Profile Status</i> Profile State	Off (62) Running (149) Pause (146)	Off	Instance 1 Map 1 Map 2 294 3802	0x7A (122) 1 2	-----	22002	Inst. 1 2902 Offset + 80	init R
No Dis- play	<i>Profile Status</i> Active File	0 to 4	0	Instance 1 Map 1 Map 2 295 3804	0x7A (122) 1 2	-----	22003	Inst. 1 2904 Offset + 80	init R
No Dis- play	<i>Profile Status</i> Total Step Time Remain- ing In seconds	0.0 to 9999.000	0.0	Instance 1 Map 1 Map 2 303 3816	0x7A (122) 1 9	-----	22009	Inst. 1 2916 Offset + 80	float RW
Ent 1 [Ent1]	<i>Profile Status</i> *Active Event Output 1 View or change the event output states.	<input type="checkbox"/> oFF Off (62) <input type="checkbox"/> oN On (63)	Off	Instance 1 Map 1 Map 2 ----- 3826	0x7A (122) 1 0xE (14)	-----	22014	Inst. 1 2926 Offset + 80	usint RW
Ent 2 [Ent2]	<i>Profile Status</i> *Active Event Output 2 View or change the event output states.	<input type="checkbox"/> oFF Off (62) <input type="checkbox"/> oN On (63)	Off	Instance 1 Map 1 Map 2 ----- 3828	0x7A (122) 1 0xF (15)	-----	22015	Inst. 1 2928 Offset + 80	usint RW
JC [JC]	<i>Profile Status</i> Jump Count Remaining View the jump counts remaining for the cur- rent loop. In a profile with nested loops, this may not indicate the actual jump counts remaining.	0 to 9,999	0	Instance 1 Map 1 Map 2 305 3818	0x7A (122) 1 0xA (10)	-----	22010	Inst. 1 2918 Offset + 80	uint R
<p>Note: Some values will be rounded off to fit in the four-character display. Full values can be read with other interfaces.</p> <p>If there is only one instance of a menu, no submenus will appear.</p>									R: Head W: Write E: EE- PROM S: User Set

4

Chapter 4: Setup Pages

Control Module Setup Page Parameters

To go to the Setup Page from the Home Page, press both the Up ▲ and Down ▼ keys for six seconds. **A** will appear in the upper display and **SEt** will appear in the lower display.

- Press the Up ▲ or Down ▼ key to view available menus. On the following pages top level menus are identified with

a yellow background color.

- Press the Advance Key ⏩ to enter the menu of choice.
- If a submenu exists (more than one instance), press the Up ▲ or Down ▼ key to select and then press the Advance Key ⏩ to enter.
- Press the Up ▲ or Down ▼ key to move through available

menu prompts.

- Press the Infinity Key ∞ to move backwards through the levels: parameter to submenu; submenu to menu; menu to Home Page.
- Press and hold the Infinity Key ∞ for two seconds to return to the Home Page.

A
SEt Analog Input Menu
I
A Analog Input 1 (to 2)
SEn Sensor Type
Lin Linearization
rEL RTD Leads
Unit Units
SLo Scale Low
Shi Scale High
rLo Range Low
rHi Range High
PEE Process Error Enable
PEL Process Error Low
FiL Filter
LER Error Latching
dEC Display Precision
SbA Sensor Backup

dIo
SEt Digital Input/Output Menu
I
dIo Digital Input/Output 5 (to 6)
dir Direction
Fn Output Function
F Function Instance
oCt Control
oEb Time Base
LEu Active Level
Fn Action Function
F Function Instance

LrT
SEt Limit Menu
I
LrT Limit 1
LSd Sides
LHy Hysteresis
SPLh Set Point Limit High
SPLL Set Point Limit Low
LIE Limit Integrate

LoOp
SEt Control Loop Menu
I
LoOp Control Loop 1
hA9 Heat Algorithm
CR9 Cool Algorithm

EEUn Tru-Tune+® Enable
EbnD Tru-Tune+ Band
E9n Gain
EA9r Autotune Aggressiveness
PdL Peltier Delay
UFA User Failure Action
FAiL Input Error Failure
PA9n Manual Power
LdE Open Loop Detect Enable
LdE Open Loop Detect Time
Ldd Open Loop Detect Deviation
rP Ramp Action
rSc Ramp Scale
rRt Ramp Rate
LSP Set Point Closed Limit Low
hSP Set Point Closed Limit High
SPLo Set Point Open Limit Low
SPHi Set Point Open Limit High

oEPt
SEt Output Menu
I
oEPt Output 1 (to 4)
Fn Output (2 to 4) Function
F Function Instance
oCt Control
oEb Time Base
oLo Low Power Scale
oHi High Power Scale
Fn Output (1) Function
SSe Soft Start Time

ALrT
SEt Alarm Menu
I
ALrT Alarm 1 (to 2)
AEY Type
ScR Source
ISR Instance
AHy Hysteresis
AL9 Logic
ASd Sides
ALA Latching
AbL Blocking
ASi Silencing
AdSP Display
AdL Delay

CUrr
SEt Current Menu
I
CUrr Current 1 (to 4)
CSd Sides
CUr Read Enable
CLE Limit Enable
CdE Detection Threshold
CofS Heater Current Offset

FUn
SEt Function Key Menu
I to **2**
FUn Function Key
Fn Event Function
F Function Instance

GLbL
SEt Global Menu
I
GLbL Global
C-F Display Units
ALLF AC Line Frequency
PEYP Profile Start Type
9SE Guaranteed Soak Enable
9SDI Guaranteed Soak Deviation
dPrS Display Pairs
USrS User Settings Save
USrR User Settings Restore

COm
SEt Communications Menu
I
COm Communications
AdrT Modbus Address
bAUd Baud Rate
PAR Parity
rThL Modbus Word Order
C-F Display Units
rTAP Data Map
nuS Non-Volatile Save

To go to the Setup Page from the Home Page, press both the Up and Down keys for six seconds. will appear in the upper display and will appear in the lower display.

- Press the Up or Down key to move through the menus.
- Press the Advance Key to move to a submenu.
- Press the Up or Down key to move through the submenus.
- Press the Advance Key to move through the parameters of the menu or submenu.

- Press the Infinity Key to move backwards through the levels: parameter to submenu; submenu to menu; menu to Home Page.
- Press and hold the Infinity Key for two seconds to return to the Home Page.

Note:

Avoid continuous writes within loops. Excessive writes to EEPROM will cause premature EEPROM failure. The EEPROM is rated for 1,000,000 writes. Navigate to Setup Page under the CoM menu and set prompt Non-volatile Save to No.

Setup Page

Display	Parameter Name Description	Range	Default	Modbus Relative Address	CIP Class Instance Attribute hex (dec)	Pro DP Index	Par ID	RUI/GTW Modbus	Data Type & Read/Write
 Analog Input Menu									
 [SEn]	Analog Input (1 to 2) Sensor Type Set the analog sensor type to match the device wired to this input. Note: There is no open-sensor detection for process inputs.	Off (62) Thermocouple (95) Millivolts (56) Volts dc (104) Milliamps dc (112) RTD 100 Ω (113) RTD 1,000 Ω (114)		Instance 1 <i>Map 1 Map 2</i> 42 368 Instance 2 <i>Map 1 Map 2</i> 70 458	0x68 (104) 1 to 2 5	3	4005	Inst. 1 368 Inst. 2 528	uint RWES
 [Lin]	Analog Input (1 to 2) Linearization Set the linearization to match the thermocouple wired to this input.	J (46) F (30) E (26) D (23) C (15) B (11) T (93) S (84) R (80) N (58) K (48)	J	Instance 1 <i>Map 1 Map 2</i> 43 370 Instance 2 <i>Map 1 Map 2</i> 71 460	0x68 (104) 1 to 2 6	4	4006	Inst. 1 370 Inst. 2 530	uint RWES
 [rt.L]	Analog Input (1 to 2) RTD Leads Set to match the number of leads on the RTD wired to this input.	2 (1) 3 (2)	2	Instance 1 <i>Map 1 Map 2</i> 44 372 Instance 2 <i>Map 1 Map 2</i> 72 462	0x68 (104) 1 to 2 7	----	4007	Inst. 1 372 Inst. 2 532	uint RWES
 [Unit]	Analog Input (1 to 2) Units Set the type of units the sensor will measure.	Absolute Temperature (1540) Relative Humidity (1538) Process (75) Power (73)	Process	Instance 1 <i>Map 1 Map 2</i> ---- 442 Instance 2 <i>Map 1 Map 2</i> ---- 532	0x68 (104) 1 to 2 0x2A (42)	5	4042	----	uint RWES
Note: Some values will be rounded off to fit in the four-character display. Full values can be read with other interfaces. If there is only one instance of a menu, no submenus will appear.									R: Read W: Write E: EEPROM S: User Set

Setup Page

Display	Parameter Name Description	Range	Default	Modbus Relative Address	CIP Class Instance Attribute hex (dec)	Pro DP Index	Par ID	RUI/ GTW Mod- bus	Data Type & Read/ Write
<u>S.Lo</u> [S.Lo]	<i>Analog Input (1 to 2)</i> Scale Low Set the low scale for process inputs. This value, in millivolts, volts or milliamps, will correspond to the Range Low output of this function block.	-100.0 to 1,000.0	0.0	Instance 1 Map 1 Map 2 57 388 Instance 2 Map 1 Map 2 85 478	0x68 (104) 1 to 2 0xF (15)	6	4015	Inst. 1 388 Inst. 2 548	float RWES
<u>S.hi</u> [S.hi]	<i>Analog Input (1 to 2)</i> Scale High Set the high scale for process inputs. This value, in millivolts, volts or milliamps, will correspond to the Range High output of this function block.	-100.0 to 1,000.0	20.0	Instance 1 Map 1 Map 2 59 390 Instance 2 Map 1 Map 2 87 480	0x68 (104) 1 to 2 0x10 (16)	7	4016	Inst. 1 390 Inst. 2 550	float RWES
<u>r.Lo</u> [r.Lo]	<i>Analog Input (1 to 2)</i> Range Low Set the low range for this function block's output.	-1,999.000 to 9,999.000	0.0	Instance 1 Map 1 Map 2 61 392 Instance 2 Map 1 Map 2 89 482	0x68 (104) 1 to 2 0x11 (17)	8	4017	Inst. 1 392 Inst. 2 552	float RWES
<u>r.hi</u> [r.hi]	<i>Analog Input (1 to 2)</i> Range High Set the high range for this function block's output.	-1,999.000 to 9,999.000	9,999	Instance 1 Map 1 Map 2 63 394 Instance 2 Map 1 Map 2 91 484	0x68 (104) 1 to 2 0x12 (18)	9	4018	Inst. 1 394 Inst. 2 554	float RWES
<u>PEE</u> [P.EE]	<i>Analog Input (1 to 2)</i> Process Error Enable Turn the Process Error Low feature on or off.	<u>OFF</u> Off (62) <u>LOW</u> Low (53)	Off	Instance 1 Map 1 Map 2 ---- 418 Instance 2 Map 1 Map 2 ---- 508	0x68 (104) 1 to 2 0x1E (30)	10	4030	----	uint RWES
<u>PEL</u> [P.EL]	<i>Analog Input (1 to 2)</i> Process Error Low If the process value drops below this value, it will trigger an input error.	-100.0 to 1,000.0	0.0	Instance 1 Map 1 Map 2 ---- 420 Instance 2 Map 1 Map 2 ---- 510	0x68 (104) 1 to 2 0x1F (31)	11	4031	----	float RWES
<u>FIL</u> [FIL]	<i>Analog Input (1 to 2)</i> Filter Filtering smooths out the process signal to both the display and the input. Increase the time to increase filtering.	0.0 to 60.0 seconds	0.5	Instance 1 Map 1 Map 2 55 386 Instance 2 Map 1 Map 2 83 476	0x68 (104) 1 to 2 0xE (14)	12	4014	Inst. 1 386 Inst. 2 546	float RWES
<p>Note: Some values will be rounded off to fit in the four-character display. Full values can be read with other interfaces.</p> <p>If there is only one instance of a menu, no submenus will appear.</p>									R: Read W: Write E: EE- PROM S: User Set

Setup Page

Display	Parameter Name Description	Range	Default	Modbus Relative Address	CIP Class Instance Attribute hex (dec)	Pro DP Index	Par ID	RUI/GTW Modbus	Data Type & Read/Write
<u>.Er</u> [i.Er]	<i>Analog Input (1 to 2)</i> Error Latching Turn input error latching on or off. If latching is on, errors must be manually cleared.	<u>oFF</u> Off (62) <u>on</u> On (63)	Off	Instance 1 Map 1 Map 2 67 414 Instance 2 Map 1 Map 2 95 504	0x68 (104) 1 to 2 0x1C (28)	----	4028	Inst. 1 414 Inst. 2 574	uint RWES
<u>dEC</u> [dEC]	<i>Analog Input (1 to 2)</i> Display Precision Set the precision of the displayed value.	<u>0</u> Whole (105) <u>00</u> Tenths (94) <u>000</u> Hundredths (40) <u>0000</u> Thousandths (96)	Whole	Instance 1 Map 1 Map 2 ---- 398 Instance 2 Map 1 Map 2 ---- 488	0x68 (104) 1 to 2 0x14 (20)	----	4020	Inst. 1 398 Inst. 2 558	uint RWES
<u>SbA</u> [S.bA]	<i>Analog Input (1 to 2)</i> Sensor Backup Enable sensor backup.	<u>oFF</u> Off (62) <u>on</u> On (63)	Off	Instance 1 Map 1 Map 2 65 410 Instance 2 Map 1 Map 2 93 500	0x68 (104) 1 to 2 0x1A (26)	----	4026	Inst. 1 410 Inst. 2 570	uint RWES
<u>d io</u> <u>SEt</u> Digital Input/Output Menu									
<u>dir</u> [dir]	<i>Digital Input/Output (5 or 6)</i> Direction Set this function to operate as an input or output.	<u>DEPE</u> Output (68) <u>in</u> Input Voltage (193) <u>iCon</u> Input Dry Contact (44)	Output	Instance 5 Map 1 Map 2 169 1060 Instance 6 Map 1 Map 2 182 1090	0x6A (106) 5 to 6 1	82	6001	Inst. 5 1000 Inst. 6 1030	uint RWES
<u>Fn</u> [Fn]	<i>Digital Output (5 or 6)</i> Function Select what function will drive this output.	<u>oFF</u> Off (62) <u>HEAT</u> Heat, Control Loop (36) <u>COOL</u> Cool, Control Loop (20) <u>EntA</u> Profile Event Out A (233) <u>EntB</u> Profile Event Out B (234) <u>LiPp</u> Limit (126) <u>ALPp</u> Alarm (6)		Instance 5 Map 1 Map 2 173 1068 Instance 6 Map 1 Map 2 186 1098	0x 6A (106) 5 to 6 5	83	6005	Inst. 5 1008 Inst. 6 1068	uint RWES
<u>Fi</u> [Fi]	<i>Digital Output (5 or 6)</i> Function Instance Set the instance of the function selected above.	1 or 2	1	Instance 5 Map 1 Map 2 174 1070 Instance 6 Map 1 Map 2 187 1100	0x6A (106) 5 to 6 6	84	6006	Inst. 5 1010 Inst. 6 1040	uint RWES
<u>oCt</u> [o.Ct]	<i>Digital Output (5 or 6)</i> Control Set the output control type. This parameter is only used with PID control, but can be set anytime.	<u>FEb</u> Fixed Time Base (34) <u>vEb</u> Variable Time Base (103)	Fixed Time Base	Instance 5 Map 1 Map 2 170 1062 Instance 6 Map 1 Map 2 183 1092	0x6A (106) 5 to 6 2	85	6002	Inst. 5 1002 Inst. 6 1032	uint RWES
Note: Some values will be rounded off to fit in the four-character display. Full values can be read with other interfaces. If there is only one instance of a menu, no submenus will appear.									R: Read W: Write E: EE-PROM S: User Set

Setup Page

Display	Parameter Name Description	Range	Default	Modbus Relative Address	CIP Class Instance Attribute hex (dec)	Pro DP Index	Par ID	RUI/GTW Modbus	Data Type & Read/Write
<u>o.t.b</u> [o.tb]	<i>Digital Output (5 or 6)</i> Time Base Set the time base for fixed-time-base control.	0.1 for Fast and Bi-Directional outputs, 5.0 for Slow outputs] to 60		Instance 5 Map 1 Map 2 171 1064 Instance 6 Map 1 Map 2 184 1094	0x6A (106) 5 to 6 3	86	6003	Inst. 5 1004 Inst. 6 1034	float RWES
<u>o.Lo</u> [o.Lo]	<i>Digital Output (5 or 6)</i> Low Power Scale The power output will never be less than the value specified and will represent the value at which output scaling begins.	0.0 to 100.0	0.0	Instance 5 Map 1 Map 2 178 1076 Instance 6 Map 1 Map 2 191 1106	0x6A (106) 5 to 6 9	87	6009	Inst. 5 1016 Inst. 6 1046	float RWES
<u>o.h.i</u> [o.hi]	<i>Digital Output (5 or 6)</i> High Power Scale The power output will never be greater than the value specified and will represent the value at which output scaling stops.	0.0 to 100.0	100.0	Instance 5 Map 1 Map 2 180 1078 Instance 6 Map 1 Map 2 193 1108	0x6A (106) 5 to 6 0xA (10)	88	6010	Inst. 5 1018 Inst. 6 1048	float RWES
<u>LEu</u> [LEv]	<i>Digital Input (5 or 6)</i> Level Select which action will be interpreted as a true state.	<u>h.i.g.h</u> High (37) <u>l.o.w.l</u> Low (53)	High	Instance 5 Map 1 Map 2 264 1290 Instance 6 Map 1 Map 2 268 1310	0x6E (110) 5 to 6 1	137	10001	Inst. 5 1400 Inst. 6 1420	uint RW
<u>Fn</u> [Fn]	<i>Digital Input (5 or 6)</i> Action Function Select the function that will be triggered by a true state.	<u>n.o.n.e</u> None (61) <u>l.r.r</u> Limit Reset (82) <u>p.s.t.s</u> Profile Start/Stop (208) <u>p.r.o.f</u> Start Profile (196) <u>p.h.o.l</u> Profile Hold/Resume (207) <u>p.d.i.s</u> Profile Disable (206) <u>t.d.r</u> TRU-TUNE+™ Disable (219) <u>o.f.f</u> Switch Loop Off (62) <u>m.a.n.u.a.l</u> Manual (54) <u>t.u.n.e</u> Tune (98) <u>i.d.l.e</u> Idle Set Point (107) <u>f.a.l</u> Force Alarm to Occur (218) <u>r.o.f</u> Control Loops Off and Alarms to Non-alarm State (220) <u>s.i.l</u> Silence Alarms (108) <u>a.l.a.r.m</u> Alarm (6) <u>u.s.r.r</u> User Settings Restore (227)		Instance 5 Map 1 Map 2 266 1294 Instance 6 Map 1 Map 2 270 1314	0x6E (110) 5 to 6 3	138	10003	Inst. 5 1404 Inst. 6 1424	uint RWES
<p>Note: Some values will be rounded off to fit in the four-character display. Full values can be read with other interfaces.</p> <p>If there is only one instance of a menu, no submenus will appear.</p>									R: Read W: Write E: EE-PROM S: User Set

Setup Page

Display	Parameter Name Description	Range	Default	Modbus Relative Address	CIP Class Instance Attribute hex (dec)	Pro DP Index	Par ID	RUI/GTW Modbus	Data Type & Read/Write
<input type="checkbox"/> F , [Fi]	<i>Digital Input (5)</i> Function Instance Select which instance of the Event Function that will be triggered by a true state.	0 to 4	0	Instance 1 Map 1 Map 2 267 1296 Instance 2 Map 1 Map 2 271 1316	0x6E (110) 1 4	139	10004	Inst. 5 1406 Inst. 6 1426	uint RWES
L , P 7 <input type="checkbox"/> SEt Limit Menu									
<input type="checkbox"/> L S d [L.Sd]	<i>Limit (1)</i> Sides Select which side or sides of the process value will be monitored.	<input type="checkbox"/> bo t h Both (13) <input type="checkbox"/> h , 9 h High (37) <input type="checkbox"/> Lo l o w Low (53)	Both	Instance 1 Map 1 Map 2 279 728	0x70 (112) 1 5	40	12005	Inst. 1 688	uint RWES
<input type="checkbox"/> L h y [L.hy]	<i>Limit (1)</i> Hysteresis Set the hysteresis for the limit function. This determines how far into the safe range the process value must move before the limit can be cleared.	0.001 to 9,999.000°F or units 0.001 to 5,555.000°C	3.0°F or units 2.0°C	Instance 1 Map 1 Map 2 273 722	0x70 (112) 1 2	41	12002	Inst. 1 682	float RWES
<input type="checkbox"/> S P L h [SP.Lh]	<i>Limit (1)</i> Set Point Limit High Set the high end of the limit set point range.	-1,999.000 to 9,999.000	9,999.000	Instance 1 Map 1 Map 2 ---- 736	0x70 (112) 1 9	42	12009	Inst. 1 686	float RWES
<input type="checkbox"/> S P L L [SP.LL]	<i>Limit (1)</i> Set Point Limit Low Set the low end of the limit set point range.	-1,999.000 to 9,999.000	-1,999.000	Instance 1 Map 1 Map 2 ---- 738	0x70 (112) 1 to 4 0xA (10)	43	12010	Inst. 1 684	float RWES
<input type="checkbox"/> L , i t [L.it]	<i>Limit</i> Integrate In a limit state the controller will turn off the outputs, terminate an active profile and freeze PID and TRU-TUNE+® calculations.	<input type="checkbox"/> no No (59) <input type="checkbox"/> ye s Yes (106)	No	Instance 1 Map 1 Map 2 316 734	0x70 (112) 1 8	----	12008	Inst. 1 694	uint RWES
L o o P <input type="checkbox"/> SEt Control Loop Menu									
<input type="checkbox"/> h h g [h.Ag]	<i>Control Loop (1)</i> Heat Algorithm Set the heat control method.	<input type="checkbox"/> o f f Off (62) <input type="checkbox"/> P , i d PID (71) <input type="checkbox"/> o n - o f f On-Off (64)	PID	Instance 1 Map 1 Map 2 223 1754	0x97 (151) 1 3	72	8003	Inst. 1 1884	uint RWES
<input type="checkbox"/> C h g [C.Ag]	<i>Control Loop (1)</i> Cool Algorithm Set the cool control method.	<input type="checkbox"/> o f f Off (62) <input type="checkbox"/> P , i d PID (71) <input type="checkbox"/> o n - o f f On-Off (64)	Off	Instance 1 Map 1 Map 2 224 1756	0x97 (151) 1 4	73	8004	Inst. 1 1886	uint RWES
Note: Some values will be rounded off to fit in the four-character display. Full values can be read with other interfaces. If there is only one instance of a menu, no submenus will appear.									R: Read W: Write E: EE-PROM S: User Set

Setup Page

Display	Parameter Name Description	Range	Default	Modbus Relative Address	CIP Class Instance Attribute hex (dec)	Pro DP Index	Par ID	RUI/ GTW Mod- bus	Data Type & Read/ Write
EEUn [t.tUn]	<i>Control Loop (1)</i> TRU-TUNE+™ Enable Enable or disable the TRU-TUNE+™ adaptive tuning feature.	<input type="checkbox"/> no No (59) <input type="checkbox"/> YES Yes (106)	No	Instance 1 <i>Map 1 Map 2</i> 257 1780	0x97 (151) 1 10 (16)	----	8022	Inst. 1 1922	uint RWES
E.bnd [t.bnd]	<i>Control Loop (1)</i> TRU-TUNE+™ Band Set the range, centered on the set point, within which TRU-TUNE+™ will be in effect. Use this function only if the controller is unable to adaptive tune automatically.	0 to 100	0	Instance 1 <i>Map 1 Map 2</i> 307 1782	0x97 (151) 1 0x11 (17)	----	8034	Inst. 1 1946	uint RWES
E.gn [t.gn]	<i>Control Loop (1)</i> TRU-TUNE+™ Gain Select the responsiveness of the TRU-TUNE+™ adaptive tuning calculations. More responsiveness may increase overshoot.	1 to 6	3	Instance 1 <i>Map 1 Map 2</i> 308 1784	0x97 (151) 1 0x12 (18)	----	8035	Inst. 1 1948	uint RWES
EAgR [t.Agr]	<i>Control Loop (1)</i> Autotune Aggressiveness Select the aggressiveness of the autotuning calculations.	<input type="checkbox"/> Undr Under damped (99) <input type="checkbox"/> CrIt Critical damped (21) <input type="checkbox"/> Over Over damped (69)	Critical	Instance 1 <i>Map 1 Map 2</i> 259 1786	0x97 (151) 1 0x13 (19)	----	8024	Inst. 1 1926	uint RWES
UFA [UFA]	<i>Control Loop (1)</i> User Failure Action Select what the controller outputs will do when the user switches control to manual mode.	<input type="checkbox"/> OFF Off, sets output power to 0% (62) <input type="checkbox"/> BPLS Bumpless, maintains same output power, if it was less than 75% and stable, otherwise 0% (14) <input type="checkbox"/> MAN Manual Fixed, sets output power to Manual Power setting (33) <input type="checkbox"/> USER User, sets output power to last open-loop set point the user entered (100)	User	Instance 1 <i>Map 1 Map 2</i> 213 1912	0x6B (107) 1 0xC (12)	----	7012	Inst. 1 2182	uint RWES
FAiL [FAiL]	<i>Control Loop (1)</i> Input Error Failure Select what the controller outputs will do when an input error switches control to manual mode.	<input type="checkbox"/> OFF Off, sets output power to 0% (62) <input type="checkbox"/> BPLS Bumpless, maintains same output power, if it was less than 75% and stable, otherwise 0% (14) <input type="checkbox"/> MAN Manual Fixed, sets output power to Manual Power setting (33) <input type="checkbox"/> USER User, sets output power to last open-loop set point the user entered (100)	User	Instance 1 <i>Map 1 Map 2</i> 214 1914	0x6B (107) 1 0xD (13)	----	7013	Inst. 1 2184	uint RWES
<p>Note: Some values will be rounded off to fit in the four-character display. Full values can be read with other interfaces.</p> <p>If there is only one instance of a menu, no submenus will appear.</p>									R: Read W: Write E: EE-PROM S: User Set

Setup Page

Display	Parameter Name Description	Range	Default	Modbus Relative Address	CIP Class Instance Attribute hex (dec)	Pro DP Index	Par ID	RUI/ GTW Mod- bus	Data Type & Read/ Write
[P7Pn] [MAn]	Control Loop (1) Manual Power Set the manual output power level that will take effect if an input error failure occurs while User Failure Action is set to Manual Fixed.	Set Point Open Loop Limit Low to Set Point Open Loop Limit High (Setup Page)	0.0	Instance 1 <i>Map 1 Map 2</i> 211 1910	0x6B (107) 1 0xB (11)	----	7011	Inst. 1 2180	float RWES
[LdE] [L.dE]	Control Loop (1) Open Loop Detect Enable Turn on the open-loop detect feature to monitor a closed-loop operation for the appropriate response.	[no] No (59) [YES] Yes (106)	No	Instance 1 <i>Map 1 Map 2</i> ---- 1792	0x97 (151) 1 0x16 (22)	74	8039	----	uint RWES
[Ldt] [L.dt]	Control Loop (1) Open Loop Detect Time The Open Loop Detect Deviation value must occur for this time period to trigger an open-loop error.	0 to 3,600 seconds	240	Instance 1 <i>Map 1 Map 2</i> ---- 1794	0x97 (151) 1 0x17 (23)	75	8040	----	uint RWES
[Ldd] [L.dd]	Control Loop (1) Open Loop Detect Deviation Set the value that the process must deviate from the set point to trigger an open-loop error. Note: See: Troubleshooting section in Appendix for more information.	-1,999.000 to 9,999.000°F or units -1,110.555 to 5,555.000°C	10.0°F or units 6.0°C	Instance 1 <i>Map 1 Map 2</i> ---- 1797	0x97 (151) 1 0x18 (24)	76	8041	----	float RWES
[rP] [rP]	Control Loop (1) Ramp Action Select when the controller's set point will ramp to the defined end set point.	[OFF] Off (62) [SEr] Startup (88) [SEPE] Set Point Change (85) [both] Both (13)	Off	Instance 1 <i>Map 1 Map 2</i> 215 1916	0x6B (107) 1 0xE (14)	56	7014	Inst. 1 2186	uint RWES
[rSC] [r.SC]	Control Loop (1) Ramp Scale Select the scale of the ramp rate.	[hour] Hours (39) [P7in] Minutes (57)	Minutes	Instance 1 <i>Map 1 Map 2</i> 216 1918	0x6B (107) 1 0xF (15)	57	7015	Inst. 1 2188	uint RWES
[rRt] [r.rt]	Control Loop (1) Ramp Rate Set the rate for the set point ramp. Set the time units for the rate with the Ramp Scale parameter.	0.0 to 9,999.000°F or units 0.0 to 5,555.000°C	1.0°F or units 1.0°C	Instance 1 <i>Map 1 Map 2</i> 219 1922	0x6B (107) 1 0x11 (17)	58	7017	Inst. 1 2192	float RWES
[LSP] [L.SP]	Control Loop (1) Set Point Closed Limit Low Set the low end of the set point range.	-1,999.000 to 9,999.000°F or units -1,128.000 to 5,537.000°C	-1,999°F or units -1,128°C	Instance 1 <i>Map 1 Map 2</i> 195 1894	0x6B (107) 1 3	52	7003	Inst. 1 2164	float RWES
<p>Note: Some values will be rounded off to fit in the four-character display. Full values can be read with other interfaces.</p> <p>If there is only one instance of a menu, no submenus will appear.</p>									R: Read W: Write E: EE- PROM S: User Set

Setup Page

Display	Parameter Name Description	Range	Default	Modbus Relative Address	CIP Class Instance Attribute hex (dec)	Pro DP Index	Par ID	RUI/ GTW Mod- bus	Data Type & Read/ Write
h.SP [h.SP]	<i>Control Loop (1)</i> Set Point Closed Limit High Set the high end of the set point range.	-1,999.000 to 9,999.000°F or units -1,128.000 to 5,537.000°C	9,999°F or units 5,537°C	Instance 1 <i>Map 1 Map 2</i> 197 1896	0x6B (107) 1 4	53	7004	Inst. 1 2166	float RWES
SP.Lo [SP.Lo]	<i>Control Loop (1)</i> Set Point Open Limit Low Set the minimum value of the open-loop set point range.	-100.0 to 100.0%	-100	Instance 1 <i>Map 1 Map 2</i> 199 1898	0x6B (107) 1 5	54	7005	Inst. 1 2168	float RWES
SP.hi [SP.hi]	<i>Control Loop (1)</i> Set Point Open Limit High Set the maximum value of the open-loop set point range.	-100.0 to 100.0%	100	Instance 1 <i>Map 1 Map 2</i> 201 1900	0x6B (107) 1 6	55	7006	Inst. 1 2170	float RWES
o.k.P.t SEt Output Menu									
Fn [Fn]	<i>Output (1 to 4)</i> Function Select what function will drive this output.	oFF Off (62) ALrT Alarm (6) HErE Heat, Control Loop (36) CoOL Cool, Control Loop (20) LiM Limit (126) EnT.A Profile Event Out A (233) EnT.B Profile Event Out B (234)	off	Instance 1 <i>Map 1 Map 2</i> 134 948 [Map1 Offset + 13] [Map2 Offset + 30]	0x6A (106) 1 to 4 5	83	6005	Inst. 1 888 Offset + 30	uint RWES
Fi [Fi]	<i>Output (1 to 4)</i> Function Instance Set the instance of the function selected above.	1 to 4	1	Instance 1 <i>Map 1 Map 2</i> 135 950 [Map1 Offset + 13] [Map2 Offset + 30]	0x6A (106) 1 to 4 6	84	6006	Inst. 1 890 Offset + 30	uint RWES
o.Ct [o.Ct]	<i>Output (1 to 4)</i> Control Set the output control type. This parameter is only used with PID control, but can be set anytime.	FtB Fixed Time Base (34) vEtB Variable Time Base (103)	Fixed Time Base	Instance 1 <i>Map 1 Map 2</i> 131 942 [Map1 Offset + 13] [Map2 Offset + 30]	0x6A (106) 1 to 4 2	85	6002	Inst. 1 882 Offset + 30	uint RWES
Note: Some values will be rounded off to fit in the four-character display. Full values can be read with other interfaces. If there is only one instance of a menu, no submenus will appear.									R: Read W: Write E: EE- PROM S: User Set

Setup Page

Display	Parameter Name Description	Range	Default	Modbus Relative Address	CIP Class Instance Attribute hex (dec)	Pro DP Index	Par ID	RUI/GTW Modbus	Data Type & Read/Write
o.tb [o.tb]	Output (1 to 4) Time Base Set the time base for fixed-time-base control.	0.1 to 60.0 seconds (solid-state relay or switched dc) 5.0 to 60.0 seconds (mechanical relay or no-arc power control)	0.1 sec. [SSR & sw dc] 20.0 sec. [mech, relay, no-arc]	Instance 1 Map 1 Map 2 132 944 [Map1 Offset + 13] [Map2 Offset + 30]	0x6A (106) 1 to 4 3	86	6003	Inst. 1 884 Offset + 30	float RWES
o.Lo [o.Lo]	Output (1 to 4) Low Power Scale The power output will never be less than the value specified and will represent the value at which output scaling begins.	0.0 to 100.0%	0.0%	Instance 1 Map 1 Map 2 139 956 [Map1 Offset + 13] [Map2 Offset + 30]	0x6A (106) 1 to 4 9	87	6009	Inst. 1 896 Offset + 30	float RWES
o.hi [o.hi]	Output (1 to 4) High Power Scale The power output will never be greater than the value specified and will represent the value at which output scaling stops.	0.0 to 100.0%	100.0%	Instance 1 Map 1 Map 2 141 958 [Map1 Offset + 13] [Map2 Offset + 30]	0x6A (106) 1 to 4 0xA (10)	88	6010	Inst. 1 898 Offset + 30	float RWES
Fn [Fn]	Output (1) Function Select what function will drive this output.	o.OFF Off (62) h.E.R.L Heat, Control Loop (36) o.O.L Cool, Control Loop (20))	off	Instance 1 Map 1 Map 2 ---- 782 1 2	0x6A (118) 1 2	----	18002	----	uint RWES
SS.ti [SS.ti]	Output (1) Soft Start Time Set the time (in seconds) it takes to achieve 100% power	0.0 to 1000.0 seconds	0	Instance 1 Map 1 Map 2 ---- 820	0x76 (118) 1 0x15 (21)	----	18021	----	float RWES
ALP? SEE Alarm Menu									
ALY [A.ty]	Alarm (1 to 2) Type Select whether the alarm trigger is a fixed value or will track the set point.	o.OFF Off (62) P.r.AL Process Alarm (76) d.E.AL Deviation Alarm (24)	Off	Instance 1 Map 1 Map 2 110 1478 Instance 2 Map 1 Map 2 126 1538	0x6D (109) 1 to 2 0xF (15)	20	9015	Inst. 1 1508 Inst. 2 1558	uint RWES
Sr.A [Sr.A]	Alarm (1 to 2) Source Function A Select what will trigger this alarm.	A , Analog Input (142) C.U.r.r Current (22) P.L.U.r Power, Control Loop (73)		Instance 1 Map 1 Map 2 111 1482 Instance 2 Map 1 Map 2 127 1542	0x6D (109) 1 to 2 0x11 (17)	21	9017	Inst. 1 1512 Inst. 2 1562	uint RWES
Note: Some values will be rounded off to fit in the four-character display. Full values can be read with other interfaces. If there is only one instance of a menu, no submenus will appear.									R: Read W: Write E: EE-PROM S: User Set

Setup Page

Display	Parameter Name Description	Range	Default	Modbus Relative Address	CIP Class Instance Attribute hex (dec)	Pro DP Index	Par ID	RUI/ GTW Mod- bus	Data Type & Read/ Write
<u>.5A</u> [i.S.A]	Alarm (1 to 2) Source Instance A Set the instance of the function selected above.	1 or 2	1	Instance 1 Map 1 Map 2 112 1484 Instance 2 Map 1 Map 2 128 1544	0x6D (109) 1 to 2 0x12 (18)	22	9018	Inst. 1 1514 Inst. 2 1564	uint RWES
<u>AHy</u> [A.hy]	Alarm (1 to 2) Hysteresis Set the hysteresis for an alarm. This determines how far into the safe region the process value needs to move before the alarm can be cleared.	0.001 to 9,999.000°F or units 0.001 to 5,555.000°C	1.0°F or units 1.0°C	Instance 1 Map 1 Map 2 101 1454 Instance 2 Map 1 Map 2 117 1514	0x6D (109) 1 to 2 3	24	9003	Inst. 1 1484 Inst. 2 1534	float RWES
<u>AL9</u> [A.Lg]	Alarm (1 to 2) Logic Select what the output condition will be during the alarm state.	<u>ALC</u> Close On Alarm (17) <u>ALO</u> Open On Alarm (66)	Close On Alarm	Instance 1 Map 1 Map 2 104 1458 Instance 2 Map 1 Map 2 120 1518	0x6D (109) 1 to 2 5	25	9005	Inst. 1 1488 Inst. 2 1538	uint RWES
<u>ASd</u> [A.Sd]	Alarm (1 to 2) Sides Select which side or sides will trigger this alarm.	<u>both</u> Both (13) <u>h,gh</u> High (37) <u>low</u> Low (53)	Both	Instance 1 Map 1 Map 2 103 1456 Instance 2 Map 1 Map 2 119 1516	0x6D (109) 1 to 2 4	26	9004	Inst. 1 1486 Inst. 2 1536	uint RWES
<u>ALA</u> [A.LA]	Alarm (1 to 2) Latching Turn alarm latching on or off. A latched alarm has to be turned off by the user.	<u>ALN</u> Non-Latching (60) <u>ALL</u> Latching (49)	Non- Latching	Instance 1 Map 1 Map 2 106 1462 Instance 2 Map 1 Map 2 122 1522	0x6D (109) 1 to 2 7	27	9007	Inst. 1 1492 Inst. 2 1542	uint RWES
<u>ABL</u> [A.bL]	Alarm (1 to 2) Blocking Select when an alarm will be blocked. After startup and/or after the set point changes, the alarm will be blocked until the process value enters the normal range.	<u>OFF</u> Off (62) <u>SEr</u> Startup (88) <u>SEPt</u> Set Point (85) <u>both</u> Both (13)	Off	Instance 1 Map 1 Map 2 107 1464 Instance 2 Map 1 Map 2 123 1524	0x6D (109) 1 to 2 8	28	9008	Inst. 1 1494 Inst. 2 1544	uint RWES
<u>ASi</u> [A.Si]	Alarm (1 to 2) Silencing Turn alarm silencing on to allow the user to disable this alarm.	<u>OFF</u> Off (62) <u>on</u> On (63)	Off	Instance 1 Map 1 Map 2 105 1460 Instance 2 Map 1 Map 2 121 1520	0x6D (109) 1 to 2 6	29	9006	Inst. 1 1490 Inst. 2 1540	uint RWES
<p>Note: Some values will be rounded off to fit in the four-character display. Full values can be read with other interfaces.</p> <p>If there is only one instance of a menu, no submenus will appear.</p>									R: Read W: Write E: EE- PROM S: User Set

Setup Page

Display	Parameter Name Description	Range	Default	Modbus Relative Address	CIP Class Instance Attribute hex (dec)	Pro DP Index	Par ID	RUI/ GTW Mod- bus	Data Type & Read/ Write
[AdSP] [A.dSP]	Alarm (1 to 2) Display Display an alarm message when an alarm is active.	<input type="checkbox"/> oFF Off (62) <input type="checkbox"/> oN On (63)	On	Instance 1 Map 1 Map 2 ---- 1480 Instance 2 Map 1 Map 2 ---- 1540	0x6D (109) 1 to 2 0x10 (16)	30	9016	Inst. 1 1510 Inst. 2 1560	uint RWES
[AdL] [A.dL]	Alarm (1 to 2) Delay Set the span of time that the alarm will be delayed after the process value ex- ceeds the alarm set point.	0 to 9,999 seconds	0	Instance 1 Map 1 Map 2 ---- 1490 Instance 2 Map 1 Map 2 ---- 1550	0x6D (109) 1 to 2 0x15 (21)	31	9021	----	uint RWES
[Curr] [SEE] Current Menu									
[Csd] [C.Sd]	Current (1) Sides Select which side or sides will be monitored.	<input type="checkbox"/> oFF Off (62) <input type="checkbox"/> h,9H High (37) <input type="checkbox"/> LoLd Low (53) <input type="checkbox"/> boTtH Both (13)	Off	Instance 1 Map 1 Map 2 283 1248	0x73 (115) 1 5	145	15005	Inst. 1 1128	uint RWES
[CUr] [C.Ur]	Current (1) Message Enable Display under/ over range current.	No (59) Yes (106)	No	Instance 1 Map 1 Map 2 ---- 1246	0x73 (115) 1 4	146	15004	Inst. 1 1126	uint RWES
[CLE] [C.LE]	Current (1) Current Limit Trip En- able	No (59) Yes (106)	No	Instance 1 Map 1 Map 2 284 1250	0x73 (115) 1 6	----	15006	Inst. 1 1130	uint RWES
[CoFS] [C.oFS]	Current (1) Heater Offset Apply an offset to the cur- rent reading	-9,999.000 to 9,999.000	0.0	Instance 1 Map 1 Map 2 ---- 1260	0x73 (115) 1 0xB (11)	149	15011	Inst. 1 1140	float RWE
No Dis- play	Current (1) Current Gain	-1,999.000 to 9,999.000	100.0	Instance 1 Map 1 Map 2 290 1258	0x73 (115) 1 0xA (10)	----	----	Inst. 1 1138	float RWE
Note: Some values will be rounded off to fit in the four-character display. Full values can be read with other interfaces. If there is only one instance of a menu, no submenus will appear.									R: Read W: Write E: EE- PROM S: User Set

Setup Page

Display	Parameter Name Description	Range	Default	Modbus Relative Address	CIP Class Instance Attribute hex (dec)	Pro DP Index	Par ID	RUI/GTW Modbus	Data Type & Read/Write
<p>Function Key</p> <p>Function Key</p>									
<p>Fn [Fn]</p>	<p><i>Function Key (1 to 2)</i> Digital Input Function Program the EZ Key to trigger an action. Functions respond to a level state change or an edge level change.</p>	<p>none None (61) Limit Reset Limit Reset, edge triggered (82) Profile Start/Stop Profile Start/Stop, level triggered (208) Profile Start Number Profile Start Number, edge triggered (196) Profile Hold/Resume Profile Hold/Resume, level triggered (207) Profile Disable Profile Disable, level triggered (206) TRU-TUNE+® Disable TRU-TUNE+® Disable, level triggered (219) Switch Control Loop Off Switch Control Loop Off, level triggered (90) Manual/Auto Mode Manual/Auto Mode, level triggered (54) Tune Tune, edge triggered (98) Idle Set Point Enable Idle Set Point Enable, level triggered (107) Force Alarm Force Alarm, level triggered (218) Alarm Outputs & Control Loop Off Alarm Outputs & Control Loop Off, level triggered (220) Silence Alarms Silence Alarms, edge triggered (108) Alarm Reset Alarm Reset, edge triggered (6) Restore User Settings Restore User Settings, edge triggered (227)</p>	None	<p>Instance 1 <i>Map 1 Map 2</i> 266 1294 Instance 2 <i>Map 1 Map 2</i> 270 1314</p>	0x6E (110) 1 to 2 3	138	10003	<p>Inst. 1 1324 Inst. 2 1344</p>	uint RWES
<p>Fi [Fi]</p>	<p><i>Function Key (1 to 2)</i> Instance Select which instance the EZ Key will affect. If only one instance is available, any selection will affect it.</p>	1 to 2	0	<p>Instance 1 <i>Map 1 Map 2</i> 267 1296 Instance 2 <i>Map 1 Map 2</i> 271 1316</p>	0x96 (110) 1 to 2 4	139	10004	<p>Inst. 1 1326 Inst. 2 1346</p>	uint RWES
No Display	<p><i>Function Key (1 to 2)</i> State</p>	Off (62) On (63)	----	<p>Instance 1 <i>Map 1 Map 2</i> ---- 960 Instance 2 <i>Map 1 Map 2</i> ---- 990</p>	0x73 (106) 1 to 2 0xB (11)	----	<p>Inst 1 3024 Inst 2 3030</p>	<p>Inst. 1 ---- Inst. 2 ----</p>	uint R
<p>Note: Some values will be rounded off to fit in the four-character display. Full values can be read with other interfaces.</p> <p>If there is only one instance of a menu, no submenus will appear.</p>									
									<p>R: Read W: Write E: EE-PROM S: User Set</p>

Setup Page

Display	Parameter Name Description	Range	Default	Modbus Relative Address	CIP Class Instance Attribute hex (dec)	Pro DP Index	Par ID	RUI/ GTW Mod- bus	Data Type & Read/ Write
9LbL SEt Global Menu									
[C_F] [C_F]	<i>Global</i> Display Units Select which scale to use for temperature.	[F] °F (30) [C] °C (15)	°F	Instance 1 Map 1 Map 2 ---- 1698	----	110	3005	----	uint RWES
[R.L.F] [AC.LF]	<i>Global</i> AC Line Frequency Set the frequency to the applied ac line power source.	[50] 50 Hz (3) [60] 60 Hz (4)	60 Hz	Instance 1 Map 1 Map 2 129 946	0x65 (101) 1 0x22 (34)	----	1034	Inst. 1 886	uint RWES
[P.tyP] [P.tyP]	<i>Global</i> Profile Start Type Set the profile startup to be based on a set point or a process value.	[SEt] Set Point (85) [Pro] Process (75)	Set Point	Instance 1 Map 1 Map 2 302 3814	0x7A (122) 1 8	----	22008	Inst. 1 2914	uint RWE
[gSE] [gSE]	<i>Global</i> Guaranteed Soak Enable Enables the guaranteed soak deviation function in profiles.	[off] Off (62) [on] On (63)	Off	Instance 1 Map 1 Map 2 299 3810	0x7A (122) 1 6	----	22006	Inst. 1 2910	uint RWE
[gSd1] [gSd1]	<i>Global</i> Guaranteed Soak Deviation 1 Set the value of the deviation band that will be used in all profile step types. The process value must enter the deviation band before the step can proceed.	0.0 to 9,999.000°F or units 0.0 to 5,555.000°C	10.0°F or units 6.0°C	Instance 1 Map 1 Map 2 300 3812	0x7A (122) 1 7	----	22007	Inst. 1 2912	float RWE
No Display	<i>Global</i> Ramping Type Defines whether profiles will use time or rate	Rate (81) Time (143)	Time	Instance 1 Map 1 Map 2 ---- 3874	0x7A (122) 1 0x26 (38)	----	22038	Inst. 1 ----	uint RWE
[d.PrS] [d.PrS]	<i>Global</i> Display Pairs Defines the number of Display Pairs.	1 to 10	2	Instance 1 Map 1 Map 2 ---- 1744	----	----	3028	----	uint RWES
[USr.S] [USr.S]	<i>Global</i> User Settings Save Save all of this controller's settings to the selected set.	[SEt1] User Set 1 (101) [SEt2] User Set 2 (102) [none] None (61)	None	Instance 1 Map 1 Map 2 17 26	0x(101) 1 0xE (14)	118	1014	Inst. 1 26	uint RWE
[USr.r] [USr.r]	<i>Global</i> User Restore Settings Replace all of this controller's settings with another set.	[Fcty] Factory (31) [none] None (61) [SEt1] User Set 1 (101) [SEt2] User Set 2 (102)	None	Instance 1 Map 1 Map 2 16 24	0x65 (101) 1 0xD (13)	117	1013	Inst. 1 24	uint RWE
Note: Some values will be rounded off to fit in the four-character display. Full values can be read with other interfaces. If there is only one instance of a menu, no submenus will appear.									R: Read W: Write E: EE-PROM S: User Set



Setup Page









Display	Parameter Name Description	Range	Default	Modbus Relative Address	CIP Class Instance Attribute hex (dec)	Pro DP Index	Par ID	RUI/ GTW Mod- bus	Data Type & Read/ Write
CoPp SEt Communications Menu									
AdPp [Ad.M]	<i>Communications (1)</i> Address Modbus Set the network address of this controller. Each device on the network must have a unique address.	1 to 247	1	Instance 1 <i>Map 1 Map 2</i> 313 2052	0x96 (150) 1 2	----	17007	Inst. 1 2320	uint RWE
bAUd [bAUd]	<i>Communications</i> Baud Rate Set the speed of this controller's communications to match the speed of the serial network.	9,600 (188) 19,200 (189) 38,400 (190)	9,600	Instance 1 <i>Map 1 Map 2</i> 314 2054	0x96 (150) 1 3	----	17002	Inst. 1 2322	uint RWE
PRr [PAr]	<i>Communications</i> Parity Set the parity of this controller to match the parity of the serial network.	none None (61) Even Even (191) odd Odd (192)	None	Instance 1 <i>Map 1 Map 2</i> 315 2056	0x96 (150) 1 4	----	17003	Inst. 1 2324	uint RWE
PpHL [M.hL]	<i>Communications</i> Modbus Word Order Select the word order of the two 16-bit words in the floating-point values.	hLo Word High Low (1330) LoH Word Low High (1331)	Low High	Instance 1 <i>Map 1 Map 2</i> ---- 2058	0x96 (150) 1 5	----	17043	----	uint RWE
C_F [C_F]	<i>Communications</i> Display Units Select which scale to use for temperature.	F °F (30) C °C (15)	°F	Instance 1 <i>Map 1 Map 2</i> ---- 2060	0x96 (150) 1 6	199	17050	----	uint RWE
PpRP [Map]	<i>Communications (1)</i> Data Map If set to 1 the control will use PM legacy mapping. If set to 2 the control will use new mapping to accommodate new functions.	1 to 2	1	Instance 1 <i>Map 1 Map 2</i> ---- ----	0x96 (117) 1 0x3B (59)	----	17059	----	uint RWE
nUS [nV.S]	<i>Communications (1)</i> Non-Volatile Save If set to Yes all values written to the control will be saved in EEPROM.	YES Yes (106) no No (59)	Yes	Instance 1 <i>Map 1 Map 2</i> 317 2064	0x96 (150) 1 8	198	17051	Inst. 1 2420	uint RWE
Note: Some values will be rounded off to fit in the four-character display. Full values can be read with other interfaces. If there is only one instance of a menu, no submenus will appear.									R: Read W: Write E: EE-PROM S: User Set

5

Chapter 5: Profiling Page

The Profiling Page allows you to enter your ramp and soak profile information.

To go to the Profiling Page from the Home Page, press the Advance Key  for three seconds, until **PROF** appears in the lower display and the profile number appears in the upper display. Press the Up  or Down  key to change to another profile.

- Press the Advance Key  to move to the selected profile's first step.
- Press the Up  or Down  keys to move through the steps.
- Press the Advance Key  to move through the selected step's settings.
- Press the Up  or Down  keys to change the step's settings.
- Press the Infinity Key  at any time to return to the step number prompt.
- Press the Infinity Key  again to return to the profile number prompt.
- From any point press and hold the Infinity Key  for two seconds to return to the Home Page.





Note:

Changes made to profile parameters in the Profiling Pages will be saved and will also have an immediate impact on the running profile.

Some parameters in the Profile Status Menu can be changed for the currently running profile, but should only be changed by knowledgeable personnel and with caution. Changing parameters via the Profile Status Menu will not change the stored profile but will have an immediate impact on the profile that is running.

How to Start a Profile

After defining the profile follow the steps below to run the profile:

1. From the Home Page push the Advance Key  repeatedly until Profile Start **PROF 1** appears in the lower display.
2. Use the Up  or Down  key to choose the file or step number within a profile where you want the profile to begin running.
3. Press the Advance Key . This takes you to Profile Action **PROF 1**, where you can select the appropriate action.

appropriate action.

- **none** No action
- **PROF** Begin execution from first step of the specified profile number, whether it exists or not.
- **PAUS** Pause the currently running profile.
- **RESU** Resume running the profile from the previously paused step.
- **End** End the profile.
- **STEP** Begin running the profile from the specified step number.

Note:

Avoid continuous writes within loops. Excessive writes to EEPROM will cause premature EEPROM failure. The EEPROM is rated for 1,000,000 writes. Navigate to Setup Page under the Com menu and set prompt Non-volatile Save **nonv** to No.

Profiling Parameters

```

PROF Profile
  PI to P4
    P1 Step 1 (to 10)
    P2 Step 11 (to 20)
    P3 Step 21 (to 30)
    P4 Step 31 (to 40)
  STEP Step Type
  ESPI Target Set Point Loop 1
  hour Hours
  min Minutes
  SEC Seconds
  rate Rate
  LDP1 Wait For Process 1
  LD1 Wait Event 1
  LD2 Wait Event 2
  JS Jump Step
  JC Jump Count
  End End Type
  Ent1 Event 1
  Ent2 Event 2

```

Note:

This page appears only if 10th digit of part number is P
ST _ _ _ _ _ P _ _

Profile Page

Display	Parameter Name Description	Range	Default	Modbus Relative Address	CIP Class Instance Attribute hex (dec)	Pro DP Index	Par ID	RUI/GTW Mod-bus	Data Type & Read/Write
[SEYP] [S.typ]	<i>Step (1 to 40)</i> Step Type Select a step type. Time or rate depending on setting of profile type found on the Setup Page in the the Global menu.	[USEP] Unused Step (50) [E] Time (143) [End] End [JL] Jump Loop (116) [UJb] Wait For Both (210) [UJPr] Wait For Process (209) [UJE] Wait For Event (144) [SoRH] Soak (87) [rRE] Rate (81)	Unused	Instance 1 <i>Map 1 Map 2</i> 500 4000 [Map1 Offset + 20] [Map2 Offset + 100]	0x79 (121) 1 to (40) 1	----	21001	Inst. 1 2870 Offset +80	uint RWE
[ESP1] [t.SP1]	<i>Step (1 to 40)</i> Target Set Point Loop 1 Set the set point for this loop.	-1,999.000 to 9,999.000 °F or -1,128.000 to 5,537.000 °C	0.0	Instance 1 <i>Map 1 Map 2</i> 501 4002 [Map1 Offset + 20] [Map2 Offset + 100]	0x79 (121) 1 to (40) 2	----	21002	Inst. 1 2872 Offset +80	float RWE
[hoUr] [hoUr]	<i>Step (1 to 40)</i> Hours Select the hours (plus Minutes and Seconds) for a timed step.	0 to 99	0	Instance 1 <i>Map 1 Map 2</i> 503 4004 [Map1 Offset + 20] [Map2 Offset + 100]	0x79 (121) 1 to (40) 3	----	21003	Inst. 1 2874 Offset +80	uint RWE
[Min] [Min]	<i>Step (1 to 40)</i> <i>Step Type Parameters</i> Minutes Select the minutes (plus Hours and Seconds) for a timed step.	0 to 59	0	Instance 1 <i>Map 1 Map 2</i> 504 4006 [Map1 Offset + 20] [Map2 Offset + 100]	0x79 (121) 1 to (40) 4	----	21004	Inst. 1 2876 Offset +80	uint RWE
[SEC] [SEC]	<i>Step (1 to 40)</i> Seconds Select the seconds (plus Hours and Minutes) for a timed step.	0 to 59	0	Instance 1 <i>Map 1 Map 2</i> 505 4008 [Map1 Offset + 20] [Map2 Offset + 100]	0x79 (121) 1 to (40) 5	----	21005	Inst. 1 2878 Offset +80	uint RWE
[rAtE] [rAtE]	<i>Step (1 to 40)</i> Rate Select the rate for ramping in degrees or units per minute.	0 to 9,999.000°F or units per minute 0 to 5,555.000°C per minute	0.0	Instance 1 <i>Map 1 Map 2</i> 506 4010 [Map1 Offset + 20] [Map2 Offset + 100]	0x79 (121) 1 to (40) 6	----	21006	Inst. 1 2880 Offset +80	float RWE
<p>Note: Some values will be rounded off to fit in the four-character display. Full values can be read with other interfaces.</p> <p>If there is only one instance of a menu, no submenus will appear.</p>									R: Read W: Write E: EE-PROM S: User Set

Profile Page

Display	Parameter Name Description	Range	Default	Modbus Relative Address	CIP Class Instance Attribute hex (dec)	Pro DP Index	Par ID	RUI/GTW Modbus	Data Type & Read/Write
<u>W.P1</u> [W.P1]	Step (1 to 40) Wait For Process 1	-1,999.000 to 9,999.000°F or units -1,128.000 to 5,537.000°C	0.0°F or units -18.0°C	Instance 1 Map 1 Map 2 512 4020 [Map1 Offset + 20] [Map2 Offset + 100]	0x79 (121) 1 to (40) 0xB (11)	----	21011	Inst. 1 2890 Offset +80	float RWE
<u>WE.1</u> [WE.1]	Step (1 to 40) Wait Event 1	<u>none</u> None (61) <u>on</u> On (63) <u>off</u> Off (62)	None	Instance 1 Map 1 Map 2 510 4016 [Map1 Offset + 20] [Map2 Offset + 100]	0x79 (121) 1 to (40) 9	----	21009	Inst. 1 2886 Offset +80	uint RWE
<u>WE.2</u> [WE.2]	Step (1 to 40) Wait Event 2	<u>none</u> None (61) <u>on</u> On (63) <u>off</u> Off (62)	None	Instance 1 Map 1 Map 2 511 4018 [Map1 Offset + 20] [Map2 Offset + 100]	0x79 (121) 1 to (40) 0xA (10)	----	21010	Inst. 1 2888 Offset +80	uint RWE
<u>JS</u> [JS]	Step (1 to 40) Jump Step Select a step to jump to.	Step-1 (Minimum of 1)	1	Instance 1 Map 1 Map 2 514 4022 [Map1 Offset + 20] [Map2 Offset + 100]	0x79 (121) 1 to (40) 0xC (12)	----	21012	Inst. 1 2892 Offset +80	uint RWE
<u>JC</u> [JC]	Step (1 to 40) Jump Count Set the number of jumps. A value of 0 creates an infinite loop. Loops can be nested four deep.	0 to 9,999	1	Instance 1 Map 1 Map 2 515 4024 [Map1 Offset + 20] [Map2 Offset + 100]	0x79 (121) 1 to (40) 0xD (13)	----	21013	Inst. 1 2894 Offset +80	uint RWE
<u>End</u> [End]	Step (1 to 40) End Type Select what the controller will do when this profile ends.	<u>off</u> Control Mode set to Off (62) <u>Hold</u> Hold last closed- loop set point in the pro- file (47) <u>User</u> User, reverts to pre- vious set point (100)	User	Instance 1 Map 1 Map 2 516 4026 [Map1 Offset + 20] [Map2 Offset + 100]	0x79 (121) 1 to (40) 0xE (14)	----	21014	Inst. 1 2896 Offset +80	uint RWE
<p>Note: Some values will be rounded off to fit in the four-character display. Full values can be read with other interfaces.</p> <p>If there is only one instance of a menu, no submenus will appear.</p>									R: Read W: Write E: EE- PROM S: User Set

Profile Page

Display	Parameter Name Description	Range	Default	Modbus Relative Address	CIP Class Instance Attribute hex (dec)	Pro DP Index	Par ID	RUI/GTW Mod-bus	Data Type & Read/Write
<u>Ent1</u> [Ent1]	<i>Step (1 to 40)</i> Event 1 Select whether Event Output 1 is on, unchanged or off during this step.	<input type="checkbox"/> OFF Off (62) <input type="checkbox"/> Uc9d Unchanged (1557) <input type="checkbox"/> on On (63)	Off	Instance 1 <i>Map 1 Map 2</i> 508 4012 [Map1 Offset + 20] [Map2 Offset + 100]	0x79 (121) 1 to (40) 7	----	21007	Inst. 1 2882 Offset +80	uint RWE
<u>Ent2</u> [Ent2]	<i>Step (1 to 40)</i> Event 2 Select whether Event Output 2 is on, unchanged or off during this step.	<input type="checkbox"/> OFF Off (62) <input type="checkbox"/> Uc9d Unchanged (1557) <input type="checkbox"/> on On (63)	Off	Instance 1 <i>Map 1 Map 2</i> 509 4014 [Map1 Offset + 20] [Map2 Offset + 100]	0x79 (121) 1 to (40) 8	----	21008	Inst. 1 2884 Offset +80	uint RWE
No Display	<i>Step (1 to 40)</i> Event Input 1 Current state of digital input 5.	Off (62) On (63)	----	Instance 1 <i>Map 1 Map 2</i> ---- 3866	0x7A (122) 1 0x22 (34)	----	22034	Inst. 1 ----	uint R
No Display	<i>Step (1 to 40)</i> Event Input 2 Current state of digital input 6.	Off (62) On (63)	----	Instance 1 <i>Map 1 Map 2</i> ---- 3868	0x7A (122) 1 0x23 (35)	----	22035	Inst. 1 ----	uint R
Note: Some values will be rounded off to fit in the four-character display. Full values can be read with other interfaces. If there is only one instance of a menu, no submenus will appear.									R: Read W: Write E: EE-PROM S: User Set



Display	Step Type Description	Parameters in Step Type
<u>ti</u> [ti]	<i>Step Types</i> Time A Time Step controls at the Target Set Point and maintains two event output states for the designated time.	<u>tsP</u> Target Set Point <u>hour</u> Hours <u>min</u> Minutes <u>SEC</u> Seconds <u>Ent1</u> Event Output 1 <u>Ent2</u> Event Output 2
<u>rAtE</u> [rAtE]	<i>Step Types</i> Rate A Rate Step ramps the process value to the Target Set Point in degrees per minute while maintaining two event output states.	<u>tsP</u> Target Set Point <u>rAtE</u> Rate <u>Ent1</u> Event Output 1 <u>Ent2</u> Event Output 2
<u>WJE</u> [W.E]	<i>Step Types</i> Wait For Event A Wait Event Step will wait for the event input states to match the two Wait Event settings.	<u>WJE.1</u> Wait Event 1 (digital input 5) <u>WJE.2</u> Wait Event 2 (digital input 6) <u>Ent1</u> Event Output 1 <u>Ent2</u> Event Output 2
<u>WPr</u> [W.Pr]	<i>Step Types</i> Wait For Process A Wait For Process Step will wait for the process value to match the Wait For Process value.	<u>WPr</u> Wait For Process Instance <u>WPrV</u> Wait For Process Value <u>Ent1</u> Event Output 1 <u>Ent2</u> Event Output 2
<u>Wbo</u> [W.bo]	<i>Step Types</i> Wait For Both A Wait For Both will wait for the process value to match the Wait For Process value and the Event Step will wait for the event input states to match the two Wait Event settings.	<u>WPrV</u> Wait For Process Value <u>WJE.1</u> Wait Event 1 (digital input 5) <u>WJE.2</u> Wait Event 2 (digital input 6) <u>Ent1</u> Event Output 1 <u>Ent2</u> Event Output 2





Display	Step Type Description	Parameters in Step Type
<input type="checkbox"/> JL [JL]	<i>Step Types</i> Jump Loop A Jump Loop step will jump to the Jump Step the number of times designated in Jump Count. Loops can be nested up to four deep.	<input type="checkbox"/> JS Jump Step <input type="checkbox"/> JC Jump Count <input type="checkbox"/> Ent1 Event Output 1 <input type="checkbox"/> Ent2 Event Output 2
<input type="checkbox"/> End [End]	<i>Step Types</i> End An End Step will end the profile. If a profile doesn't include an End Step, control will move to the next step. If no End Step is confronted, after step 40 control will default to the set point in effect before the profile started.	<input type="checkbox"/> End End Type
<input type="checkbox"/> USEP [UStP]	<i>Step Types</i> Unused Step This is an empty step that can be used to, in effect, erase a step in a profile.	

6

Chapter 6: Factory Pages

Control Module Factory Page Parameters

To go to the Factory Page from the Home Page, press and hold both the Advance  and Infinity  keys for six seconds.

- Press the Advance Key  to move through the parameter prompts.
- Press the Up  or Down  keys to change the parameter value.
- Press the Infinity Key  to return to the Home Page.

Note:

Some of these menus and parameters may not appear, depending on the modules options. See model number information in the Appendix for more information. If there is only one instance of a menu, no submenus will appear.

Calculating the Modbus Register

The tables below list only the register of the first instance of each parameter. To find the register of the other instances, use the formula: instance (n) register = instance 1 register + ((n - 1) * offset).

[USE]
[FCEY] Custom Setup Menu
 [] 1 to [] 20
 [USE] Custom Setup
 [PAR] Parameter
 [id] Instance ID

[Loc]
[FCEY] Security Setting Menu
 [Loc] Security Setting
 [Loco] Operations Page
 [LocP] Profiling Page
 [PASE] Password Enable
 [rLoc] Read Lock
 [SLoc] Write Security
 [LocL] Locked Access Level
 [roLL] Rolling Password
 [PASSu] User Password
 [PASSA] Administrator Password

***[ULoc]**
[FCEY] Security Setting Menu
 [Loc] Security Setting
 [CodE] Public Key
 [PASS] Password

[d.R9]
[FCEY] Diagnostics Menu
 [d.R9] Diagnostics
 [Pn] Part Number
 [rEu] Software Revision
 [SbLd] Software Build Number
 [Sn] Serial Number
 [dATE] Date of Manufacture

[CAL]
[FCEY] Calibration Menu
 [] 1
 [ACE] Calibration 1 (to 4)
 [P7u] Electrical Measurement
 [ELio] Electrical Input Offset

[ELiS] Electrical Input Slope
[ELoo] Electrical Output Offset
[ELoS] Electrical Output Slope

* Visible only when Password Enable found in the Loc menu is turned on.

Display	Parameter Name Description	Range	Default	Modbus Relative Address	CIP Class Instance Attribute hex (dec)	Pro DP Index	Par ID	RUI/GTW Modbus	Data Type & Read/Write
[CUSE] [FCEY] Custom Setup Menu									
[PAR] [Par]	<p><i>Custom</i> Parameter 1 to 20 Select the parameters that will appear in the Home Page.</p> <p>The Parameter 1 value will appear in the upper display of the Home Page. It cannot be changed with the Up and Down Keys in the Home Page.</p> <p>The Parameter 2 value will appear in the lower display in the Home Page. It can be changed with the Up and Down Keys, if the parameter is a writable one.</p> <p>Scroll through the other Home Page parameters with the Advance Key .</p>	<p>[none] None (61)</p> <p>[LSE] Limit Status (1668)</p> <p>[LHY] Limit Hysteresis (183)</p> <p>[LHS] Limit High Set Point (182)</p> <p>[LLS] Limit Low Set Point (181)</p> <p>[CUR] Sensed Current (179)</p> <p>[GSD] Guaranteed Soak Deviation 1 Value (1214)</p> <p>[PAR] Profile Action Request (109)</p> <p>[PST] Profile Start (79)</p> <p>[IDLE] Idle Set Point (107)</p> <p>[tTUN] TRU-TUNE+® Enable (205)</p> <p>[RR] Ramp Rate (177)</p> <p>[CHY] Cool Hysteresis (170)</p> <p>[CPB] Cool Proportional Band (169)</p> <p>[HHY] Heat Hysteresis (167)</p> <p>[HPB] Heat Proportional Band (166)</p> <p>[db] Dead Band (164)</p> <p>[td] Time Derivative (163)</p> <p>[TI] Time Integral (162)</p> <p>[CPR] Cool Power (161)</p> <p>[HPR] Heat Power (160)</p> <p>[CM] User Control Mode (159)</p> <p>[AUT] Autotune (158)</p> <p>[OP] Open Loop Set Point (110)</p> <p>[ALSP] Active Set Point (72)</p> <p>[APV] Active Process Value (25)</p> <p>[SPE] Set Point (85)</p> <p>[CUSE] Custom Menu (180)</p> <p>[AHY] Alarm Hysteresis (97)</p> <p>[AHI] Alarm High Set Point (78)</p> <p>[ALO] Alarm Low Set Point (42)</p> <p>[USR] User Restore Set (1171)</p> <p>[CF] Display Units (156)</p> <p>[ICR] Input Calibration Offset (154)</p> <p>[PRO] Process (75)</p>	See: Home Page	Instance 1 Map 1 Map 2 -----	----		14005		uint RWES
[iid] [iid]	<p><i>Custom (1 to 20)</i> Instance ID Select the parameters that will appear in the Home Page.</p>	1 to 2	----	Instance 1 Map 1 Map 2 -----	----	----	14003		uint RWES
[LoC] [FCEY] Security Setting Menu									
[LoCo] [LoC.o]	<p><i>Security Setting</i> Operations Page Change the security level of the Operations Page.</p>	1 to 3	2	Instance 1 Map 1 Map 2 ----- 1692	----	----	3002	----	uint RWE
<p>Note: Some values will be rounded off to fit in the four-character display. Full values can be read with another interface.</p> <p>If there is only one instance of a menu, no submenus will appear.</p>									R: Read W: Write E: EE-PROM S: User Set

Display	Parameter Name Description	Range	Default	Modbus Relative Ad- dress	CIP Class Instance Attribute hex (dec)	Pro DP Index	Par ID	RUI/ GTW Mod- bus	Data Type & Read/ Write
LoCP [LoC.P]	<i>Security Setting</i> Profiling Page Change the security level of the Profiling Page.	1 to 3	3	Instance 1 Map 1 Map 2 ---- 1704	----	----	3008	----	uint RWE
PRSE [LoC.P]	<i>Security Setting</i> Password Enable Turn security features on or off.	<input type="checkbox"/> oFF Off <input type="checkbox"/> oN On	Off	Instance 1 Map 1 Map 2 ---- ----	----	----	3009	----	uint RWE
rLoL [rLoC]	<i>Security Setting</i> Read Lock Set the read security clearance level. The user can access the selected level and all lower levels. If the Set Lockout Security level is higher than the Read Lockout Security, the Read Lockout Security level takes priority.	1 to 5	5	Instance 1 Map 1 Map 2 ---- 1708	----	----	3010	----	uint RWE
SLoL [SLoC]	<i>Security Setting</i> Write Security Set the write security clearance level. The user can access the selected level and all lower levels. If the Set Lockout Security level is higher than the Read Lockout Security, the Read Lockout Security level takes priority.	0 to 5	5	Instance 1 Map 1 Map 2 ---- 1710	----	----	3011	----	uint RWE
LoLl [LoC.L]	<i>Security Setting</i> Locked Access Level Determines user level menu visibility when security is enabled. See Features section under Password Security.	1 to 5	5	Instance 1 Map 1 Map 2 ---- ----	----	----	3016	----	uint RWE
roLL [roLL]	<i>Security Setting</i> Rolling Password When power is cycled a new Public Key will be displayed.	<input type="checkbox"/> oFF Off <input type="checkbox"/> oN On	Off	Instance 1 Map 1 Map 2 ---- ----	----	----	3019	----	uint RWE
PASu [PAS.u]	<i>Security Setting</i> User Password Used to acquire access to menus made available through the Locked Access Level setting.	10 to 999	63	Instance 1 Map 1 Map 2 ---- ----	----	----	3017	----	uint RWE
Note: Some values will be rounded off to fit in the four-character display. Full values can be read with another interface.									R: Read W: Write E: EE- PROM S: User Set
If there is only one instance of a menu, no submenus will appear.									

Display	Parameter Name Description	Range	Default	Modbus Relative Address	CIP Class Instance Attribute hex (dec)	Pro DP Index	Par ID	RUI/GTW Mod-bus	Data Type & Read/Write
PAS.A [PAS.A]	<i>Security Setting</i> Administrator Password Used to acquire full access to all menus.	10 to 999	156	Instance 1 Map 1 Map 2 -----	----	----	3018	----	uint RWE
ULoC FCEY Security Setting Menu									
CodE [CodE]	<i>Security Setting</i> Public Key If Rolling Password turned on, generates a random number when power is cycled. If Rolling Password is off fixed number will be displayed.	Customer Specific	0	Instance 1 Map 1 Map 2 -----	----	----	3020	----	uint RWE
PASS [PASS]	<i>Security Setting</i> Password Number returned from calculation found in Features section under Password Security.	-1999 to 9999	0	Instance 1 Map 1 Map 2 -----	----	----	3022	----	uint RWE
d.r9 FCEY Diagnostics Menu									
Pn [Pn]	<i>Diagnostics</i> Model Number Display the model number.	14	----	Instance 1 Map 1 Map 2 -----	0x65 (101) 1 9	116	1009	----	dint R
rEv [rEv]	<i>Diagnostics</i> Firmware Revision Display the firmware revision.	5	----	Instance 1 Map 1 Map 2 4 4	0x65 (101) 1 0x11 (17)	----	1003	Inst. 1 4	dint R
S.bLd [S.bLd]	<i>Diagnostics</i> Software Build Number Display the firmware build number.	0 to 2,147,483,647		Instance 1 Map 1 Map 2 8 8	0x65 (101) 1 5	----	1005	Inst. 1 8	dint R
Sn [Sn]	<i>Diagnostics</i> Serial Number Display the serial number.	0 to 2,147,483,647		Instance 1 Map 1 Map 2 12 12	0x65 (101) 1 0x20 (32)	----	1032	Inst. 1 12	string R
dAtE [dAtE]	<i>Diagnostics</i> Date of Manufacture Display the date code.	0 to 2,147,483,647	----	Instance 1 Map 1 Map 2 14 14	0x65 (101) 1 8	----	1008	Inst. 1 14	dint R
Note: Some values will be rounded off to fit in the four-character display. Full values can be read with another interface. If there is only one instance of a menu, no submenus will appear.									R: Read W: Write E: EE-PROM S: User Set

Control Module • Factory Page

Display	Parameter Name Description	Range	Default	Modbus Relative Address	CIP Class Instance Attribute hex (dec)	Pro DP Index	Par ID	RUI/GTW Modbus	Data Type & Read/Write
No Display	<i>Diagnostics</i> Hardware ID Display hardware ID.	17 or 31		Instance 1 Map 1 Map 2 0 0	0x65 (101) 1 1	----	1001	Inst. 1 ----	dint R
No Display	<i>Diagnostics</i> Software ID Display software ID.	0 to 2147483647	----	Instance 1 Map 1 Map 2 2 2	0x65 (101) 1 2	----	1002	Inst. 1 ----	dint R
No Display	<i>Diagnostics</i> Device Name	0 or 32	EZ-ZONE ST	Instance 1 Map 1 Map 2 0 0	0x65 (101) 1 0x0B(11)	----	1011	Inst. 1 ----	string RWE
No Display	<i>Diagnostics</i> Device Status	OK (138) FAIL (32)	----	Instance 1 Map 1 Map 2 18 30	0x65 (101) 1 0x0A(10)	----	1016	Inst. 1 ----	uint R
<p>CAL FEY Calibration Menu</p>									
[Mv] [Mv]	<i>Calibration (1 to 2)</i> Electrical Measurement Read the raw electrical value for this input in the units corresponding to the Sensor Type (Setup Page, Analog Input Menu) setting.	-3.4e38 to 3.4e38		Instance 1 Map 1 Map 2 309 400 Instance 2 Map 1 Map 2 311 490	0x68 (104) 1 to 2 0x15 (21)	----	4021	Inst. 1 400 Inst. 2 560	float R
[ELi.o] [ELi.o]	<i>Calibration (1 to 2)</i> Electrical Input Offset Change this value to calibrate the low end of the input range.	-1,999.000 to 9,999.000	0.0	Instance 1 Map 1 Map 2 47 378 Instance 2 Map 1 Map 2 75 468	0x68 (104) 1 to 2 0xA (10)	----	4010	Inst. 1 378 Inst. 2 538	float RWES
[ELi.S] [ELi.S]	<i>Calibration (1 to 2)</i> Electrical Input Slope Adjust this value to calibrate the slope of the input value.	-1,999.000 to 9,999.000	1.0	Instance 1 Map 1 Map 2 49 380 Instance 2 Map 1 Map 2 77 470	0x68 (104) 1 to 2 0xB (11)	----	4011	Inst. 1 380 Inst. 2 540	float RWES
[ELo.o] [ELo.o]	<i>Calibration (1)</i> Electrical Output Offset Change this value to calibrate the low end of the output range.	-1,999.000 to 9,999.000	0.0	Instance 1 Map 1 Map 2 ---- 788	0x76 (118) 1 5	----	18005	----	float RWES
[ELo.S] [ELo.S]	<i>Calibration (1)</i> Electrical Output Slope Adjust this value to calibrate the slope of the output value.	-1,999.000 to 9,999.000	1.0	Instance 1 Map 1 Map 2 ---- 790	0x76 (118) 1 6	----	18006	----	float RWES
<p>Note: Some values will be rounded off to fit in the four-character display. Full values can be read with another interface.</p> <p>If there is only one instance of a menu, no submenus will appear.</p>									<p>R: Read W: Write E: EE-PROM S: User Set</p>

7

Chapter 7: Features

Saving and Restoring User Settings	65
Tuning the PID Parameters	65
Manual Tuning	65
Autotuning with TRU-TUNE+®	66
Inputs	66
Calibration Offset	66
Calibration	67
Filter Time Constant	67
Sensor Selection	67
Set Point Low Limit and High Limit	68
Scale High and Scale Low	68
Range High and Range Low	68
Control Methods	68
Output Configuration	68
Auto (closed loop) and Manual (open loop) Control	68
On-Off Control	69
Proportional Control	69
Proportional plus Integral (PI) Control	70
Proportional plus Integral plus Derivative (PID) Control	70
Dead Band	70
Variable Time Base	71
Phase Angle	71
Soft Start Time	71
Single Set Point Ramping	71
Alarms	72
Process and Deviation Alarms	72
Alarm Set Points	72
Alarm Hysteresis	72
Alarm Latching	72
Alarm Silencing	73
Alarm Blocking	73
Using Lockout to Hide Pages and Menus	73
Using Password Security	74
Modbus - Using Programmable Memory Blocks	75
CIP - Communications Capabilities	75
Software Configuration	76

Note:

In the following chapter, there will be many visual references to prompts as related to the features and as seen on the face of the Remote User Interface (RUI) which is optional hardware. To learn more about the RUI point your browser to: http://www.watlow.com/literature/pti_search.cfm?dltype=5 and type in EZ-ZONE in the search field at the bottom of the page to find and download the RUI/Gateway User Manual.

Saving and Restoring User Settings

Recording setup and operations parameter settings for future reference is very important. If you unintentionally change these, you will need to program the correct settings back into the controller to return the equipment to operational condition.

After you program the controller and verify proper operation, use User Save Set **[USR.S]** (Setup Page, Global Menu) to save the settings into either of two files in a special section of memory. If the settings in the controller are altered and you want to return the controller to the saved values, use User Restore Set **[USR.R]** (Setup Page, Global Menu) to recall one of the saved settings.

A digital input or the RUI Function Key can also be configured to restore parameters.

Note:

Only perform the above procedure when you are sure that all the correct settings are programmed into the controller. Saving the settings overwrites any previously saved collection of settings. Be sure to document all the controller settings.

Tuning the PID Parameters

Autotuning

When an autotune is performed on the EZ-ZONE® ST, the set point is used to calculate the tuning set point.

For example, if the active set point is 200° and Autotune Set Point **[AESP]** (Operations Page, Loop Menu) is set to 90 percent, the autotune function utilizes 180° for tuning. This is also how autotuning works in previous Watlow controllers. In addition, changing the active set point in previous controllers causes the autotune function to restart; where with the EZ-ZONE ST changing the set point after an autotune has been started has no affect.

A new feature in EZ-ZONE ST products will allow set point changes while the control is autotuning, this includes while running a profile or ramping. When the auto tune is initially started it will use the current set point and will disregard all set point changes until the tuning process is complete. Once complete, the controller will then use the new set point.

This is why it is a good idea to enter the active set point before initiating an autotune.

Autotuning calculates the optimum heating and/or cooling PID parameter settings based on the system's response. Autotuning can be enabled whether or not TUNE-TUNE+® is enabled. The PID settings generated by the autotune will be used until the autotune feature is rerun, the PID values are manually adjusted or TRU-TUNE+® is enabled.

To initiate an autotune, set Autotune Request **[AUE]** (Operations Page, Loop Menu) to **[YES]**. You should not autotune while a profile is running. If the autotune cannot be completed in 60 minutes, the autotune will time-out and the original settings will take effect.

The lower display will flash between **[TUNE]** and

the set point while the autotuning is underway. The temperature must cross the Autotune Set Point five times to complete the autotuning process. Once complete, the controller controls at the normal set point, using the new parameters.

Select a set point for the tune with Autotune Set Point. The Autotune Set Point is expressed as a percent of the Closed Loop Set Point.

If you need to adjust the tuning procedure's aggressiveness, use Autotune Aggressiveness **[TAGR]** (Setup Page, Loop Menu). Select under damped **[Undr]** to bring the process value to the set point quickly. Select over damped **[over]** to bring the process value to the set point with minimal overshoot. Select critical damped **[crit]** to balance a rapid response with minimal overshoot.

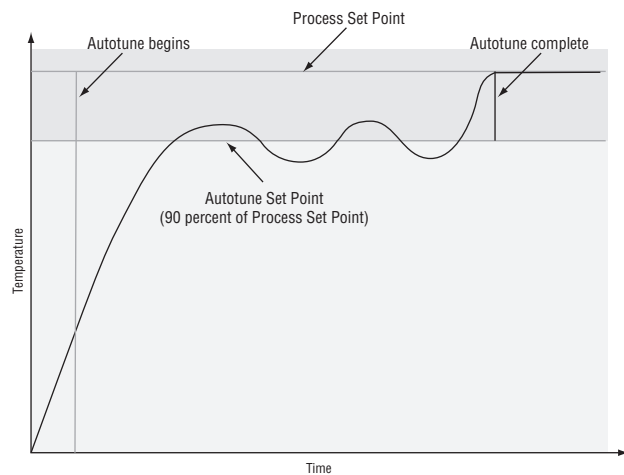

Manual Tuning

In some applications, the autotune process may not provide PID parameters for the process characteristics you desire. If that is the case, you may want to tune the controller manually.

1. Apply power to the controller and establish a set point typically used in your process.
2. Go to the Operations Page, Loop Menu, and set Heat Proportional Band **[hPb]** and/or Cool Proportional Band **[cPb]** to 5. Set Time Integral **[ti]** to 0. Set Time Derivative **[td]** to 0.
3. When the system stabilizes, watch the process value. If it fluctuates, increase the Heat Proportional Band or Cool Proportional Band value in 3 to 5° increments until it stabilizes, allowing time for the system to settle between adjustments.
4. When the process has stabilized, watch Heat Power **[hPr]** or Cool Power **[cPr]** (Operations Page, Monitor Menu). It should be stable $\pm 2\%$. At this point, the process temperature should also be stable, but it will have stabilized before reaching the set point. The difference between the set point and actual process value can be eliminated with Integral.
5. Start with an Integral value of 6,000 and allow 10 minutes for the process temperature to reach

the set point. If it has not, reduce the setting by half and wait another 10 minutes. Continue reducing the setting by half every 10 minutes until the process value equals the set point. If the process becomes unstable, the Integral value is too small. Increase the value until the process stabilizes.

6. Increase Derivative to 0.1. Then increase the set point by 11° to 17°C. Monitor the system's approach to the set point. If the process value overshoots the set point, increase Derivative to 0.2. Increase the set point by 11° to 17°C and watch the approach to the new set point. If you increase Derivative too much, the approach to the set point will be very sluggish. Repeat as necessary until the system rises to the new set point without overshoot or sluggishness.

For additional information about autotune and PID control, see related features in this chapter.

Autotuning with TRU-TUNE+®

The TRU-TUNE+ adaptive algorithm will optimize the controller's PID values to improve control of dynamic processes. TRU-TUNE+ monitors the process variable and adjusts the control parameters automatically to keep your process at set point during set point and load changes. When the controller is in the adaptive control mode, it determines the appropriate output signal and, over time, adjusts control parameters to optimize responsiveness and stability. The TRU-TUNE+ feature does not function for on-off control.

The preferred and quickest method for tuning a loop is to establish initial control settings and continue with the adaptive mode to fine tune the settings.

Setting a controller's control mode to tune starts this two-step tuning process. (See Autotuning in this chapter.) This predictive tune determines initial, rough settings for the PID parameters. Then the loop automatically switches to the adaptive mode which fine tunes the PID parameters.

Once the process variable has been at set point for a suitable period (about 30 minutes for a fast process to roughly two hours for a slower process) and if no further tuning of the PID parameters is desired or needed, TRU-TUNE+ may be turned off. However, keeping the controller in the adaptive mode allows it to automatically adjust to load changes and compensate for differing control characteristics at various set points for processes that are not entirely linear.

Once the PID parameters have been set by the TRU-TUNE+ adaptive algorithm, the process, if shut down for any reason, can be restarted in the adaptive control mode.

Turn TRU-TUNE+ on or off with TRU-TUNE+ Enable **[E.TUN]** (Setup Page, Loop Menu).

Use TRU-TUNE+ Band **[E.bnd]** (Setup Page, Loop Menu) to set the range above and below the set point in which adaptive tuning will be active. Adjust this parameter only in the unlikely event that the controller is unable to stabilize at the set point with TRU-

TUNE+ Band set to auto (0). This may occur with very fast processes. In that case, set TRU-TUNE+™ Band to a large value, such as 100.

Use TRU-TUNE+ Gain **[E.GN]** (Setup Page, Loop Menu) to adjust the responsiveness of the adaptive tuning calculations. Six settings range from 1, with the most aggressive response and most potential overshoot (highest gain), to 6, with the least aggressive response and least potential for overshoot (lowest gain). The default setting, 3, is recommended for loops with thermocouple feedback and moderate response and overshoot potential.

Before Tuning

Before autotuning, the controller hardware must be installed correctly, and these basic configuration parameters must be set:

- Sensor Type **[SEn]** (Setup Page, Analog Input Menu), and scaling, if required;
- Function **[Fn]** (Setup Page, Output Menu) and scaling, if required.

How to Autotune a Loop

1. Enter the desired set point or one that is in the middle of the expected range of set points that you want to tune for.
2. Enable TRU-TUNE+®.
3. Initiate an autotune. (See Autotuning in this chapter.)

When autotuning is complete, the PID parameters should provide good control. As long as the loop is in the adaptive control mode, TRU-TUNE+® continuously tunes to provide the best possible PID control for the process.



WARNING! During autotuning, the controller sets the output to 100 percent and attempts to drive the process variable toward the set point. Enter a set point and heat and cool power limits that are within the safe operating limits of your system.

Inputs

Calibration Offset

Calibration offset allows a device to compensate for an inaccurate sensor, lead resistance or other factors that affect the input value. A positive offset increases the input value, and a negative offset decreases the input value.

The input offset value can be viewed or changed with Calibration Offset **[.CA]** (Operations Page, Analog Input Menu).

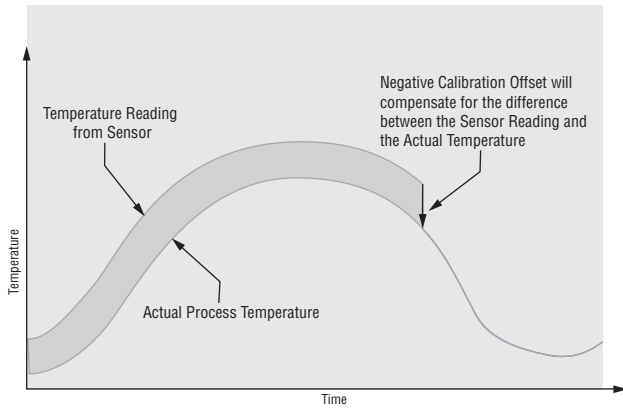

Calibration

To calibrate an analog input, you will need to provide two electrical signals or resistance loads near the extremes of the range that the application is likely to utilize. See recommended values below:

Sensor Type	Low Source	High Source
thermocouple	0.000 mV	50.000 mV
millivolts	0.000 mV	50.000 mV
volts	0.000V	10.000V
milliamps	0.000 mA	20.000 mA
100 Ω RTD	50.00 Ω	350.00 Ω
1,000 Ω RTD	500.00 Ω	3,500.00 Ω

Follow these steps for a thermocouple or process input:

1. Apply the low source signal to the input you are calibrating. Measure the signal to ensure it is accurate.
2. Read the value of Electrical Measurement **[P7U]** (Factory Page, Calibration Menu) for that input.
3. Calculate the offset value by subtracting this value from the low source signal.
4. Set Electrical Input Offset **[EL 1.0]** (Factory Page, Calibration Menu) for this input to the offset value.
5. Check the Electrical Measurement to see whether it now matches the signal. If it doesn't match, adjust Electrical Input Offset again.
6. Apply the high source signal to the input. Measure the signal to ensure it is accurate.
7. Read the value of Electrical Measurement for that input.
8. Calculate the gain value by dividing the low source signal by this value.
9. Set Electrical Input Slope **[EL 1.5]** (Factory Page, Calibration Menu) for this input to the calculated gain value.
10. Check the Electrical Measurement to see whether it now matches the signal. If it doesn't match, adjust Electrical Input Slope again.

Set Electrical Input Offset to 0 and Electrical Input Slope to 1 to restore factory calibration.

Follow these steps for an RTD input:

1. Measure the low source resistance to ensure it is

accurate. Connect the low source resistance to the input you are calibrating.

2. Read the value of Electrical Measurement **[P7U]** (Factory Page, Calibration Menu) for that input.
3. Calculate the offset value by subtracting this value from the low source resistance.
4. Set Electrical Input Offset **[EL 1.0]** (Factory Page, Calibration Menu) for this input to the offset value.
5. Check the Electrical Measurement to see whether it now matches the resistance. If it doesn't match, adjust Electrical Offset again.
6. Measure the high source resistance to ensure it is accurate. Connect the high source resistance to the input.
7. Read the value of Electrical Measurement for that input.
8. Calculate the gain value by dividing the low source signal by this value.
9. Set Electrical Input Slope **[EL 1.5]** (Factory Page, Calibration Menu) for this input to the calculated gain value.
10. Check the Electrical Measurement to see whether it now matches the signal. If it doesn't match, adjust Electrical Input Slope again.

Set Electrical Input Offset to 0 and Electrical Input Slope to 1 to restore factory calibration.

Filter Time Constant

Filtering smoothes an input signal by applying a first-order filter time constant to the signal. Filtering the displayed value makes it easier to monitor. Filtering the signal may improve the performance of PID control in a noisy or very dynamic system.

Adjust the filter time interval with Filter Time **[F 1.1]** (Setup Page, Analog Input Menu).

Example: With a filter value of 0.5 seconds, if the process input value instantly changes from 0 to 100 and remained at 100, the display will indicate 100 after five time constants of the filter value or 2.5 seconds.

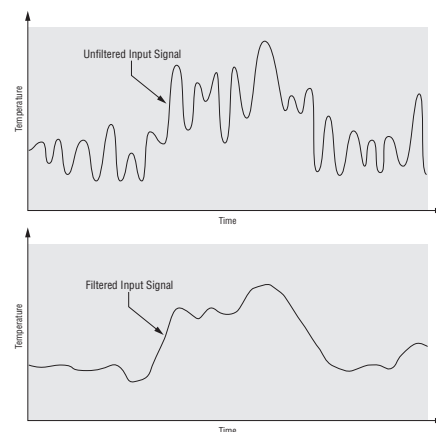

Filter Time Constant

Sensor Selection

You need to configure the controller to match the input device, which is normally a thermocouple, RTD or process transmitter.

Select the sensor type with Sensor Type **[SEN]** (Setup Page, Analog Input Menu).

Set Point Low Limit and High Limit

The controller constrains the set point to a value between a set point low limit and a set point high limit.

Set the set point limits with Low Set Point **[LSP]** and High Set Point **[HSP]** (Setup Page, Loop Menu).

There are two sets of set point low and high limits: one for a closed-loop set point, another for an open-loop set point.

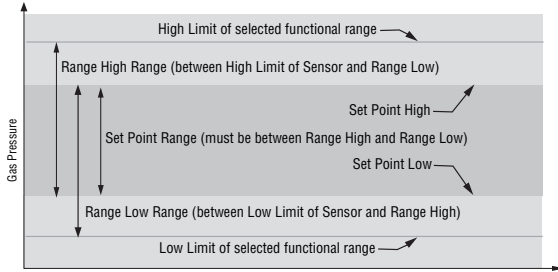

Scale High and Scale Low

When an analog input is selected as process voltage or process current input, you must choose the value of voltage or current to be the low and high ends. For example, when using a 4 to 20 mA input, the scale low value would be 4.00 mA and the scale high value would be 20.00 mA. Commonly used scale ranges are: 0 to 20 mA, 4 to 20 mA, 0 to 5V, 1 to 5V and 0 to 10V.

You can create a scale range representing other units for special applications. You can reverse scales from high values to low values for analog input signals that have a reversed action. For example, if 50 psi causes a 4 mA signal and 10 psi causes a 20 mA signal.

Scale low and high values do not have to match the bounds of the measurement range. These along with range low and high provide for process scaling and can include values not measurable by the controller. Regardless of scaling values, the measured value will be constrained by the electrical measurements of the hardware.

Select the low and high values with Scale Low **[SL0]** and Scale High **[SH1]**. Select the displayed range with Range Low **[rLo]** and Range High **[rHi]** (Setup Page, Analog Input Menu).

Range High and Range Low

With a process input, you must choose a value to represent the low and high ends of the current or voltage range. Choosing these values allows the controller's display to be scaled into the actual working units of measurement. For example, the analog input from a humidity transmitter could represent 0 to 100 percent relative humidity as a process signal of 4 to 20 mA. Low scale would be set to 0 to represent 4 mA and high scale set to 100 to represent 20 mA. The indication on the display would then represent percent humidity and range from 0 to 100 percent with an input of 4 to 20 mA.

Select the low and high values with Range Low **[rLo]** and Range High **[rHi]** (Setup Page, Analog Input Menu).

Control Methods

Output Configuration

Each controller output (1, 2 and 3) can be configured as a heat output, a cool output, an alarm output or deactivated. No dependency limitations have been placed on the available combinations. The outputs can be configured in any combination. For instance, all three could be set to cool.

Heat and cool outputs use the set point and Operations parameters to determine the output value. All heat and cool outputs use the same set point value. Heat and cool each have their own set of control parameters. All heat outputs use the same set of heat control parameters and all cool outputs use the same set of cool output parameters.

Each alarm output has its own set of configuration parameters and set points, allowing independent operation.

Auto (closed loop) and Manual (open loop) Control

The controller has two basic modes of operation, auto mode and manual mode. Auto mode allows the controller to decide whether to perform closed-loop control or to follow the settings of Input Error Failure **[FAIL]** (Setup Page, Loop Menu). The manual mode only allows open-loop control. The EZ-ZONE ST controller is normally used in the auto mode. The manual mode is usually only used for specialty applications or for troubleshooting.

Manual mode is open-loop control that allows the user to directly set the power level to the controller's output load. No adjustments of the output power level occur based on temperature or set point in this mode.

In auto mode, the controller monitors the input to determine if closed-loop control is possible. The controller checks to make certain a functioning sensor is providing a valid input signal. If a valid input signal is present, the controller will perform closed-loop control. Closed-loop control uses a process sensor to determine the difference between the process value and the set point. Then the controller applies power to a control output load to reduce that difference.

If a valid input signal is not present, the controller will indicate an input error message in the upper display and **[REtn]** in the lower display and respond to the failure according to the setting of Input Error Failure **[FAIL]**. You can configure the controller to perform a "bumpless" transfer **[BPLS]**, switch power to output a preset fixed level **[PFRn]**, or turn the output power off.

Bumpless transfer will allow the controller to transfer to the manual mode using the last power value calculated in the auto mode if the process had stabilized at a ± 5 percent output power level for the time interval of Time Integral (Operations Page, Loop)

prior to sensor failure, and that power level is less than 75 percent.

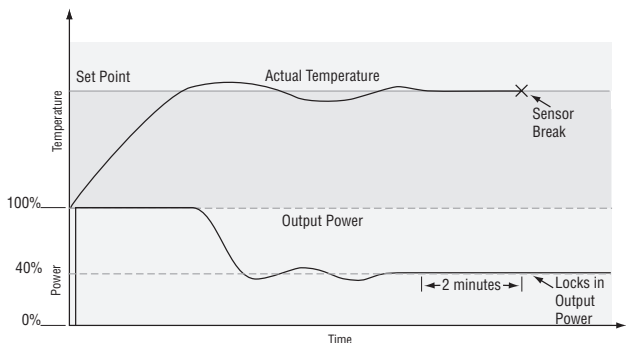

Input Error Latching **[IER]** (Setup Page, Analog Input Menu) determines the controller’s response once a valid input signal returns to the controller. If latching is on, then the controller will continue to indicate an input error until the error is cleared. To clear a latched alarm, press the Advance Key **[FWD]** then the Up Key **[UP]**.

If latching is off, the controller will automatically clear the input error and return to reading the temperature. If the controller was in the auto mode when the input error occurred, it will resume closed-loop control. If the controller was in manual mode when the error occurred, the controller will remain in open-loop control.

The Manual Control Indicator Light **[MCL]** is on when the controller is operating in manual mode.

You can easily switch between modes if the Control Mode **[CM]** parameter is selected to appear in the Home Page.

To transfer to manual mode from auto mode, press the Advance Key **[FWD]** until **[CM]** appears in the lower display. The upper display will display **[AUTO]** for auto mode. Use the Up **[UP]** or Down **[DN]** keys to select **[MAN]**. The manual set point value will be recalled from the last manual operation.

To transfer to auto mode from manual mode, press the Advance Key **[FWD]** until **[CM]** appears in the lower display. The upper display will display **[MAN]** for manual mode. Use the Up **[UP]** or Down **[DN]** keys to select **[AUTO]**. The automatic set point value will be recalled from the last automatic operation.

Changes take effect after three seconds or immediately upon pressing either the Advance Key **[FWD]** or the Infinity Key **[INF]**.

On-Off Control

On-off control switches the output either full on or full off, depending on the input, set point and hysteresis values. The hysteresis value indicates the amount the process value must deviate from the set point to turn on the output. Increasing the value decreases the number of times the output will cycle. Decreasing hysteresis improves controllability. With hysteresis set to 0, the process value would stay closer to the set point, but the output would switch on and off more frequently, and may result in the output “chattering.”

On-off control can be selected with Heat Algorithm **[HAG]** or Cool Algorithm **[CAG]** (Setup Page, Loop Menu).

On-off hysteresis can be set with Heat Hysteresis **[HHY]** or Cool Hysteresis **[CHY]** (Operations Page, Loop Menu).

Note:

Input Error Failure Mode **[FAIL]** does not function in on-off control mode. The output goes off.

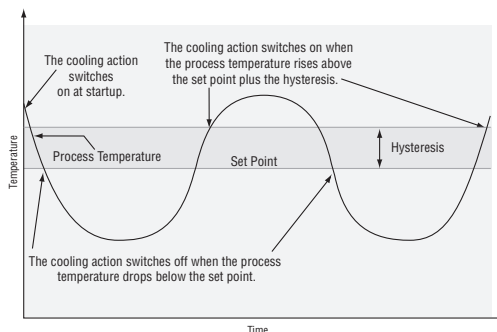
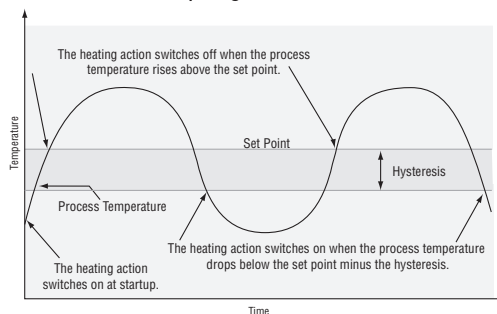

On/Off System Cycles

Proportional Control

Some processes need to maintain a temperature or process value closer to the set point than on-off control can provide. Proportional control provides closer control by adjusting the output when the temperature or process value is within a proportional band. When the value is in the band, the controller adjusts the output based on how close the process value is to the set point.

The closer the process value is to the set point, the lower the output power. This is similar to backing off on the gas pedal of a car as you approach a stop sign. It keeps the temperature or process value from swinging as widely as it would with simple on-off control. However, when the system settles down, the temperature or process value tends to “droop” short of the set point.

With proportional control the output power level equals (set point minus process value) divided by the proportional band value.

In an application with one output assigned to heating and another assigned to cooling, each will have a separate proportional parameter. The heating parameter takes effect when the process temperature is lower than the set point, and the cooling parameter takes effect when the process temperature is higher than the set point.

Adjust the proportional band with Heat Proportional Band $\boxed{h.Pb}$ or Cool Proportional Band $\boxed{C.Pb}$ (Operations Page, Loop Menu).

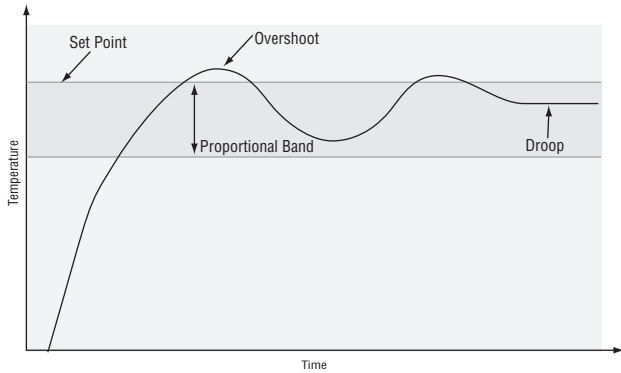

Proportional plus Integral (PI) Control

The droop caused by proportional control can be corrected by adding integral (reset) control. When the system settles down, the integral value is tuned to bring the temperature or process value closer to the set point. Integral determines the speed of the correction, but this may increase the overshoot at startup or when the set point is changed. Too much integral action will make the system unstable. Integral is cleared when the process value is outside of the proportional band.

Adjust the integral with Time Integral $\boxed{t_i}$ (Operations Page, Loop Menu).

Proportional plus Integral plus Derivative (PID) Control

Use derivative (rate) control to minimize the overshoot in a PI-controlled system. Derivative (rate) adjusts the output based on the rate of change in the temperature or process value. Too much derivative (rate) will make the system sluggish.

Derivative action is active only when the process value is within twice the proportional value from the set point.

Adjust the derivative with Time Derivative $\boxed{t_d}$ (Operations Page, Loop Menu).

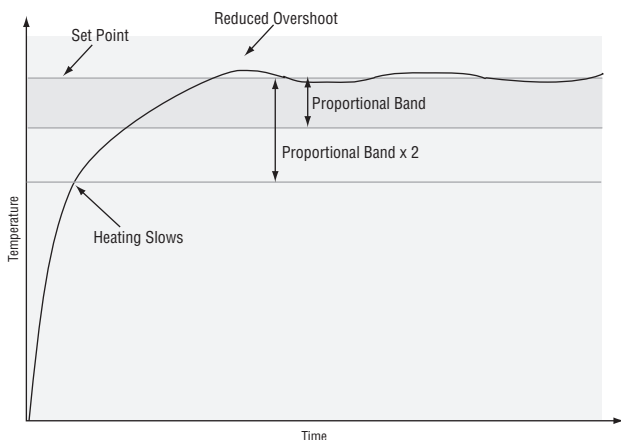

Dead Band

In a PID application the dead bands above and below the set point can save an application's energy and wear by maintaining process temperature within acceptable ranges.

Proportional action ceases when the process value is within the dead band. Integral action continues to bring the process temperature to the set point.

Using a **positive dead band value** keeps the two systems from fighting each other.

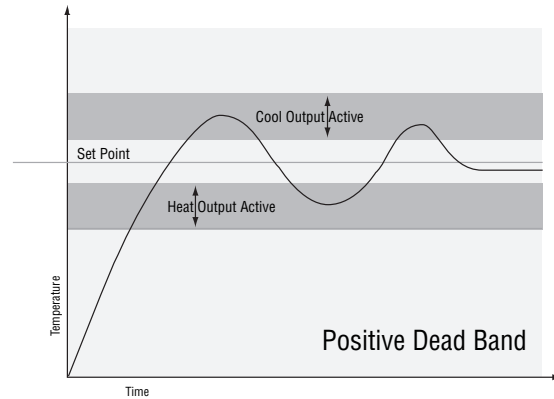

When the **dead band value is zero**, the heating output activates when the temperature drops below the set point, and the cooling output switches on when the temperature exceeds the set point.

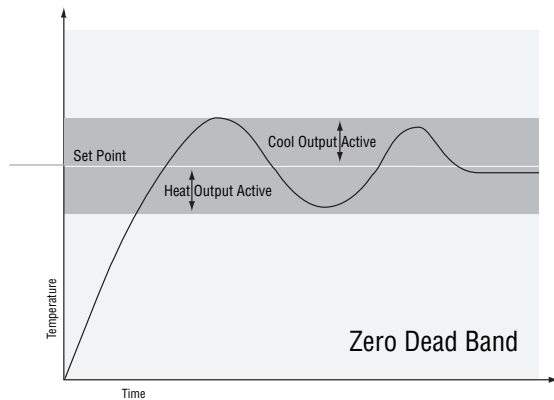

When the **dead band value is a negative value**, both heating and cooling outputs are active when the temperature is near the set point.

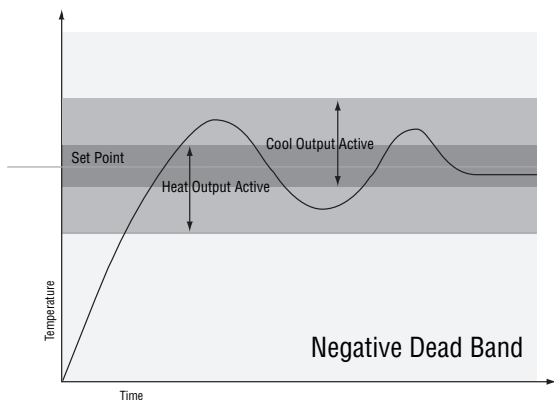

Adjust the dead band with Dead Band \boxed{db} (Operations Page, Loop Menu).

Variable Time Base

Variable time base is the preferred method for controlling a resistive load, providing a very short time base for longer heater life. Unlike phase-angle firing, variable-time-base switching does not limit the current and voltage applied to the heater.

With variable time base outputs, the PID algorithm calculates an output between 0 and 100%, but the output is distributed in groupings of three ac line cycles. For each group of three ac line cycles, the controller decides whether the power should be on or off. There is no fixed cycle time since the decision is made for each group of cycles. When used in conjunction with a zero cross (burst fire) device, such as a solid-state power controller, switching is done only at the zero cross of the ac line, which helps reduce electrical noise (RFI).

Variable time base should be used with solid-state power controllers, such as a solid-state relay (SSR) or silicon controlled rectifier (SCR) power controller. Do not use a variable time base output for controlling electromechanical relays, mercury displacement relays, inductive loads or heaters with unusual resistance characteristics.

The combination of variable time base output and a solid-state relay can inexpensively approach the effect of analog, phase-angle fired control.

Select the AC Line Frequency **ACLF** (Setup Page, Global Menu), 50 or 60 Hz.

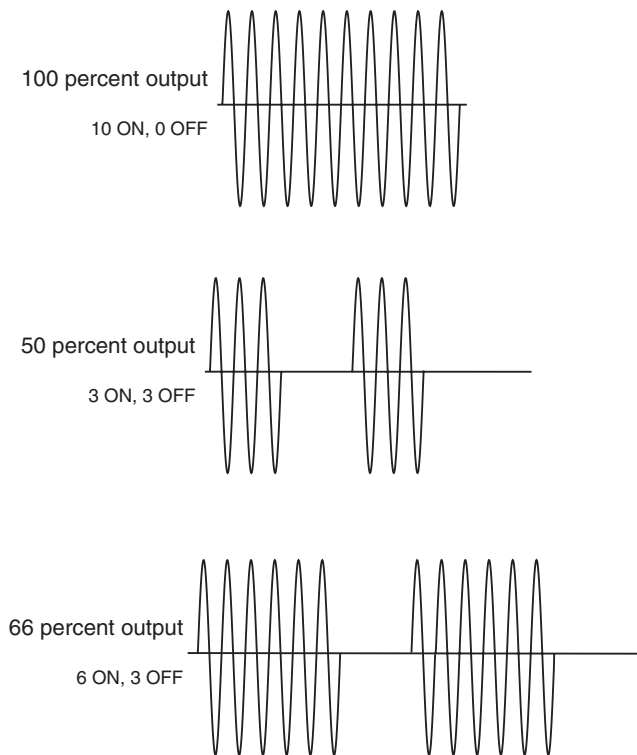

Phase Angle

The phase angle control method gates a limited portion of the line voltage cycle to the load based on the percentage power selected. Phase angle control is

variable inside the sine wave. This control method provides a variable voltage output with soft start capabilities as well.

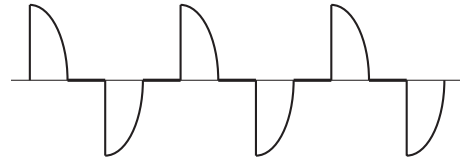

Soft Start Time

Soft start is an additional feature of phase angle control executed whenever a power increase is called for. The output will gradually increase in power until the final selected power output is reached. The soft start time is the time it takes to go from 0 to 100 percent power.

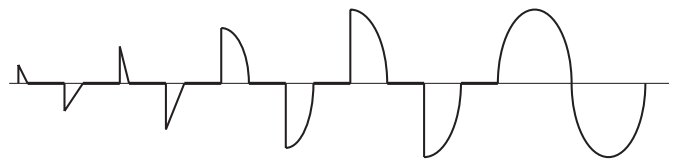

Single Set Point Ramping

Ramping protects materials and systems that cannot tolerate rapid temperature changes. The value of the ramp rate is the maximum degrees per minute or hour that the system temperature can change.

Select Ramp Action **rP** (Setup Page, Loop Menu):

oFF ramping not active.

Str ramp at startup.

StPt ramp at a set point change.

both ramp at startup or when the set point changes.

Select whether the rate is in degrees per minute or degrees per hour with Ramp Scale **rSC**. Set the ramping rate with Ramp Rate **rRt** (Setup Page, Loop Menu).

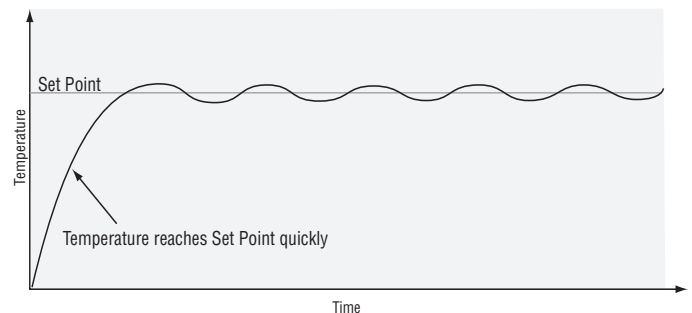

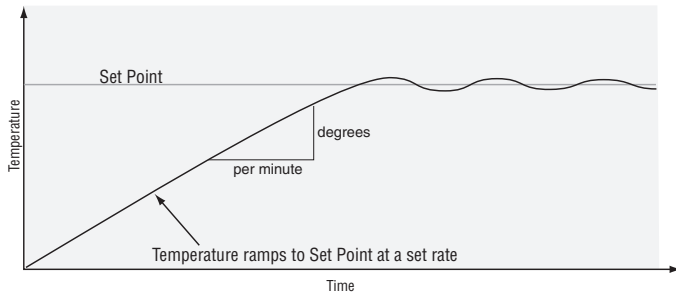

Alarms

Alarms are activated when the output level, process value or temperature leaves a defined range. A user can configure how and when an alarm is triggered, what action it takes and whether it turns off automatically when the alarm condition is over.

Configure alarm outputs in the Setup Page before setting alarm set points.

Alarms do not have to be assigned to an output. Alarms can be monitored and controlled through the front panel or by using software.

Process and Deviation Alarms

A process alarm uses one or two absolute set points to define an alarm condition.

A deviation alarm uses one or two set points that are defined relative to the control set point. High and low alarm set points are calculated by adding or subtracting offset values from the control set point. If the set point changes, the window defined by the alarm set points automatically moves with it.

Select the alarm type with Type **[ALY]** (Setup Page, Alarm Menu).

Alarm Set Points

The alarm high set point defines the process value or temperature that will trigger a high side alarm. It must be higher than the alarm low set point and lower than the high limit of the sensor range.

The alarm low set point defines the temperature that will trigger a low side alarm. It must be lower than the alarm high set point and higher than the low limit of the sensor range.

View or change alarm set points with Low Set Point **[ALo]** and High Set Point **[ALh]** (Operations Page, Alarm Menu).

Alarm Hysteresis

An alarm state is triggered when the process value reaches the alarm high or alarm low set point. Alarm hysteresis defines how far the process must return into the normal operating range before the alarm can be cleared.

Alarm hysteresis is a zone inside each alarm set point. This zone is defined by adding the hysteresis value to the alarm low set point or subtracting the

hysteresis value from the alarm high set point.

View or change alarm hysteresis with Hysteresis **[Ahy]** (Setup Page, Alarm Menu).

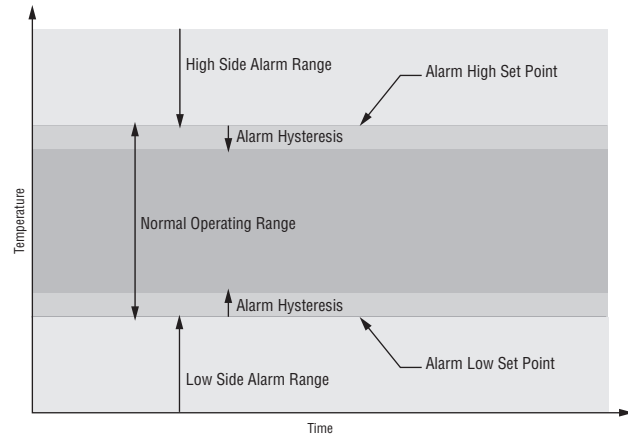

Alarm Latching

A latched alarm will remain active after the alarm condition has passed. It can only be deactivated by the user.

An active message, such as an alarm message, will cause the display to toggle between the normal settings and the active message in the upper display and **[ALEn]** in the lower display.

Push the Advance Key **[]** to display **[ALn]** in the upper display and the message source in the lower display.

Use the Up **[]** and Down **[]** keys to scroll through possible responses, such as Clear **[CLR]** or Silence **[SIL]**. Then push the Advance **[]** or Infinity **[]** key to execute the action.

See the Keys and Displays chapter and the Home Page chapter for more details.

An alarm that is not latched (self-clearing) will deactivate automatically when the alarm condition has passed.

Turn alarm latching on or off with Latching **[ALL]** (Setup Page, Alarm Menu).

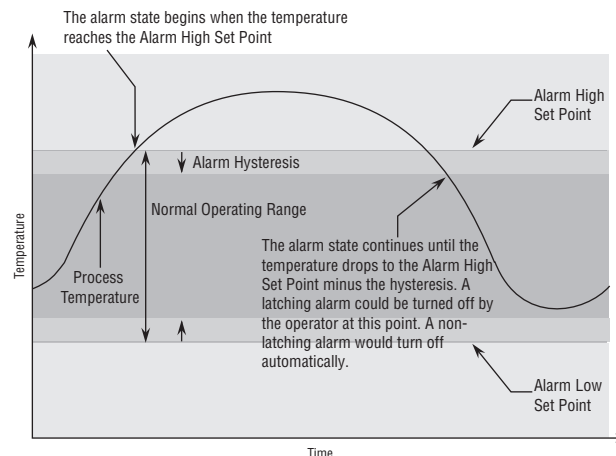

Alarm Silencing

If alarm silencing is on the operator can disable the alarm output while the controller is in an alarm state. The process value or temperature has to enter the normal operating range beyond the hysteresis zone to activate the alarm output function again.

An active message, such as an alarm message, will cause the display to toggle between the normal settings and the active message in the upper display and **ALERT** in the lower display.

Push the Advance Key **➡** to display **ALARM** in the upper display and the message source in the lower display.

Use the Up **⬆** and Down **⬇** keys to scroll through possible responses, such as Clear **CLR** or Silence **SIL**. Then push the Advance **➡** or Infinity **∞** key to execute the action.

See the Keys and Displays chapter and the Home Page chapter for more details.

Turn alarm silencing on or off with Silencing **AS** (Setup Page, Alarm Menu).

Alarm Blocking

Alarm blocking allows a system to warm up after it has been started up. With alarm blocking on, an alarm is not triggered when the process temperature is initially lower than the alarm low set point or higher than the alarm high set point. The process temperature has to enter the normal operating range beyond the hysteresis zone to activate the alarm function.

If the EZ-ZONE ST has an output that is functioning as a deviation alarm, the alarm is blocked when the set point is changed, until the process value re-enters the normal operating range.

Turn alarm blocking on or off with Blocking **ABL** (Setup Page, Alarm Menu).

Using Lockout to Hide Pages and Menus

If unintentional changes to parameter settings might raise safety concerns or lead to downtime, you can use the lockout feature to make them more secure.

Each of the menus in the Factory Page and each of the pages, except the Factory Page, has a security level assigned to it. You can change the read and write access to these menus and pages by using the parameters in the Lockout Menu (Factory Page).

Lockout Menu

There are five parameters in the Lockout Menu (Factory Page):

- Lock Operations Page **LoLo** sets the security level for the Operations Page. (default: 2)

Note:

- The Home and Setup Page lockout levels are fixed and cannot be changed.
- Lock Profiling Page **LoLP** sets the security level for the Profiling Page. (default: 3)
- Password Security Enable **PARSE** will turn on or

off the Password security feature. (default: off)

- Read Lockout Security **rLoC** determines which pages can be accessed. The user can access the selected level and all lower levels. (default: 5)
- Set Lockout Security **SLoC** determines which parameters within accessible pages can be written to. The user can write to the selected level and all lower levels. (default: 5)

The table below represents the various levels of lockout for the Set Lockout Security prompt and the Read Lockout Security prompt. The Set Lockout has 6 levels (0-5) of security where the Read Lockout has 5 (1-5). Therefore, level "0" applies to Set Lockout only. "Y" equates to yes (can write/read) where "N" equates to no (cannot write/read). The colored cells differentiate one level from the next.

Lockout Security SLoC & rLoC						
Lockout Level	0	1	2	3	4	5
Home Page	Y	Y	Y	Y	Y	Y
Operations Page	N	N	Y	Y	Y	Y
Setup Page	N	N	N	N	Y	Y
Profile Page	N	N	N	Y	Y	Y
Factory Page						
Custom Menu	N	N	N	N	N	Y
Diagnostic Menu	N	Y	Y	Y	Y	Y
Calibration Menu	N	N	N	N	N	Y
Lockout Menu						
LoLo	N	Y	Y	Y	Y	Y
LoLP	N	Y	Y	Y	Y	Y
PARSE	N	Y	Y	Y	Y	Y
rLoC	Y	Y	Y	Y	Y	Y
SLoC	Y	Y	Y	Y	Y	Y

The following examples show how the Lockout Menu parameters may be used in applications:

1. You can lock out access to the Operations Page but allow an operator access to the Profile Menu, by changing the default Profile Page and Operations Page security levels. Change Lock Operations Page **LoLo** to 3 and Lock Profiling Page **LoLP** to 2. If Set Lockout Security **SLoC** is set to 2 or higher and the Read Lockout Security **rLoC** is set to 2, the Profiling Page and Home Pages can be accessed, and all writable parameters can be written to. Pages with security levels greater than 2 will be locked out (unaccessible).
2. If Set Lockout Security **SLoC** is set to 0 and Read Lockout Security **rLoC** is set to 5, all pages will be accessible, however, changes will not be allowed on any pages or menus, with one exception: Set Lockout Security **SLoC** can be changed to a higher level.
3. The operator wants to read all the menus and not allow any parameters to be changed.

In the Factory Page, Lockout Menu, set Read

Lockout Security $rLoC$ to 5 and Set Lockout Security $SLoC$ to 0.

- The operator wants to read and write to the Home Page and Profiling Page, and lock all other pages and menus.

In the Factory Page, Lockout Menu, set Read Lockout Security $rLoC$ to 2 and Set Lockout Security $SLoC$ to 2.

In the Factory Page, Lockout Menu, set Lock Operations Page $LoC.O$ to 3 and Lock Profiling Page $LoC.P$ to 2.

- The operator wants to read the Operations Page, Setup Page, Profiling Page, Diagnostics Menu, Lock Menu, Calibration Menu and Custom Menus. The operator also wants to read and write to the Home Page.

In the Factory Page, Lockout Menu, set Read Lockout Security $rLoC$ to 1 and Set Lockout Security $SLoC$ to 5.

In the Factory Page, Lockout Menu, set Lock Operations Page $LoC.O$ to 2 and Lock Profiling Page $LoC.P$ to 3.

Using Password Security

It is sometimes desirable to apply a higher level of security to the control where a limited number of menus are visible and not providing access to others without a security password. Without the appropriate password those menus will remain inaccessible. If Password Enabled $PRSE$ in the Factory Page under the LoC Menu is set to on, an overriding Password Security will be in effect. When in effect, the only Pages that a User without a password has visibility to are defined in the Locked Access Level $LoCL$ prompt. On the other hand, a User with a password would have visibility restricted by the Read Lockout Security $rLoC$. As an example, with Password Enabled and the Locked Access Level $LoCL$ set to 1 and $rLoC$ is set to 3, the available Pages for a User without a password would be limited to the Home and Factory Pages (locked level 1). If the User password is entered all pages would be accessible with the exception of the Setup Page as defined by level 3 access.

How to Enable Password Security

Go to the Factory Page by holding down the Infinity ∞ key and the Advance \odot key for approximately six seconds. Once there, push the Down \blacktriangledown key one time to get to the LoC menu. Again push the Advance \odot key until the Password Enabled $PRSE$ prompt is visible. Lastly, push either the up or down key to turn it on. Once on, 4 new prompts will appear:

- $LoCL$, Locked Access Level (1 to 5) corresponding to the lockout table above.
- $roLL$, Rolling Password will change the Customer Code every time power is cycled.
- $PRSu$, User Password which is needed for a User to acquire access to the control.
- $PRSA$, Administrator Password which is need-

ed to acquire administrative access to the control.

The Administrator can either change the User and or the Administrator password or leave them in the default state. Once Password Security is enabled they will no longer be visible to anyone other than the Administrator. As can be seen in the formula that follows either the User or Administrator will need to know what those passwords are to acquire a higher level of access to the control. Back out of this menu by pushing the Infinity ∞ key. Once out of the menu, the Password Security will be enabled.

How to Acquire Access to the Control

To acquire access to any inaccessible Pages or Menus, go to the Factory Page and enter the $ULoC$ menu. Once there follow the steps below:

Note:

If Password Security (Password Enabled $PRSE$ is On) is enabled the two prompts mentioned below in the first step will not be visible. If unknown, call the individual or company that originally setup the control.

- Acquire either the User Password $PRSu$ or the Administrator Password $PRSA$.
- Push the Advance \odot key one time where the Code $CoDE$ prompt will be visible.

Note:

- If the the Rolling Password is off push the Advance key one more time where the Password $PRSS$ prompt will be displayed. Proceed to either step 7a or 8a. Pushing the Up \blacktriangle or Down \blacktriangledown arrow keys enter either the User or Administrator Password. Once entered, push and hold the Infinity ∞ key for two seconds to return to the Home Page.
 - If the Rolling Password $roLL$ was turned on proceed on through steps 3 - 9.
- Assuming the Public Key $CoDE$ prompt is still visible on the face of the control simply push the Advance Key \odot to proceed to the Password $PRSS$ prompt. If not find your way back to the Factory Page as described above.
 - Execute the calculation defined below (7b or 8b) for either the User or Administrator.

- Enter the result of the calculation in the upper display by using the Up \blacktriangle or Down \blacktriangledown arrow keys or use EZ-ZONE Configurator Software.
- Exit the Factory Page by pushing and holding the Infinity ∞ key for two seconds.

Formulas used by the User and the Administrator to calculate the Password follows:

Passwords equal:

7. User

- If Rolling Password $roLL$ is Off, Password $PRSS$ equals User Password $PRSu$.

b. If Rolling Password **ROLL** is On, Password **PASS** equals:

$$(\text{PASS}_u \times \text{code}) \text{ Mod } 929 + 70$$

8. Administrator

a. If Rolling Password **ROLL** is Off, Password **PASS** equals User Password **PASSA**.

b. If Rolling Password **ROLL** is On, Password **PASS** equals:

$$(\text{PASS}_A \times \text{code}) \text{ Mod } 997 + 1000$$

Differences Between a User Without Password, User With Password and Administrator

- User **without** a password is restricted by the Locked Access Level **LOCL**.
- A User **with** a password is restricted by the Read Lockout Security **rLoC** never having access to the Lock Menu **LoC**.
- An Administrator is restricted according to the Read Lockout Security **rLoC** however, the Administrator has access to the Lock Menu where the Read Lockout can be changed.

Modbus - Using Programmable Memory Blocks

When using the Modbus protocol, the ST control features a block of addresses that can be configured by the user to provide direct access to a list of 40 user configured parameters. This allows the user easy access to this customized list by reading from or writing to a contiguous block of registers.

Note:

To use the User Programmable Memory Blocks feature, Map 2 must be selected. Change the mapping **MAP** via the Setup Page under the **LoC** Menu.

To acquire a better understanding of the tables found in the back of this manual (See Appendix: [Modbus Programmable Memory Blocks](#)) please read through the text below which defines the column headers used.

Assembly Definition Addresses

- Fixed addresses used to define the parameter that will be stored in the "Working Addresses", which may also be referred to as a pointer. The value stored in these addresses will reflect (point to) the Modbus address of a parameter within the ST control.

Assembly Working Addresses

- Fixed addresses directly related to their associated "Assembly Definition Addresses" (i.e., Assembly Working Addresses 200 & 201 will assume the parameter pointed to by Assembly Definition Addresses 40 & 41).

When the Modbus address of a target parameter is stored in an "Assembly Definition Address" its corresponding working address will return that param-

eter's actual value. If it's a writable parameter, writing to its working register will change the parameter's actual value.

As an example, Modbus register 360 contains the Analog Input 1 Process Value (See Operations Page, Analog Input Menu). If the value 360 is loaded into Assembly Definition Address 91, the process value sensed by analog input 1 will also be stored in Modbus registers 250 and 251. Note that by default this parameter is also stored in working registers 240 and 241 as well.

The table (See Appendix: Modbus Programmable Memory Blocks) identified as "Assembly Definition Addresses and Assembly Working Addresses" reflects the assemblies and their associated addresses.

CIP - Communications Capabilities

CIP Communications Methodology

To communicate with the ST using CIP an RUI/GTW must be used. Reading or writing when using CIP can be accomplished via explicit and or implicit communications. Explicit communications usually requires the use of a message instruction but there are other ways to do this as well. Implicit communications is also commonly referred to as polled communications. When using implicit communications there is an I/O assembly that would be read or written to; the assemblies are embedded into the ST firmware. Watlow refers to these assemblies as the T to O (Target to Originator) and the O to T (Originator to Target) assemblies where the Target is always the ST and the Originator is the PLC or master on the network. The O to T assembly is made up of 20 (32 bit) members that are user configurable where the T to O assembly consists of 21 (32 bit) members. The first member of the T to O assembly is called the Device Status and cannot be changed. However, the 20 members that follow it are user configurable (See Appendix: [CIP Implicit O to T \(Originator to Target\) Assembly Structure](#) and [CIP Implicit T to O \(Target to Originator\) Assembly Structure](#)).

To change any given member of either assembly simply write the new class, instance and attribute to the member location of choice. As an example, if it were desired to change the 14th member of the O to T assembly from the default parameter (Heat Proportional Band) to Limit Clear Request (see Operations Page, Limit Menu) write the value of 0x70, 0x01 and 0x01 (Class, Instance and Attribute respectively) to 0x77, 0x01 and 0x0E. Once executed, writing a value of zero to this member will reset a limit assuming the condition that caused it is no longer present.

Software Configuration

Using EZ-ZONE® Configurator Software

To enable a user to configure the ST control using a personal computer (PC), Watlow has provided free software for your use. If you have not yet obtained a copy of this software insert the CD (Controller Support Tools) into your CD drive and install the software. Alternatively, if you are viewing this document electronically and have a connection to the internet simply click on the link below and download the software from the Watlow web site free of charge.

http://www.watlow.com/products/software/zone_config.cfm

Once the software is installed double click on the EZ-ZONE Configurator icon placed on your desktop during the installation process. If you cannot find the icon follow the steps below to run the software:

1. Move your mouse to the "Start" button
2. Place the mouse over "All Programs"
3. Navigate to the "Watlow" folder and then the sub-folder "EZ-ZONE Configurator"
4. Click on EZ-ZONE Configurator to run.

The first screen that will appear is shown below.

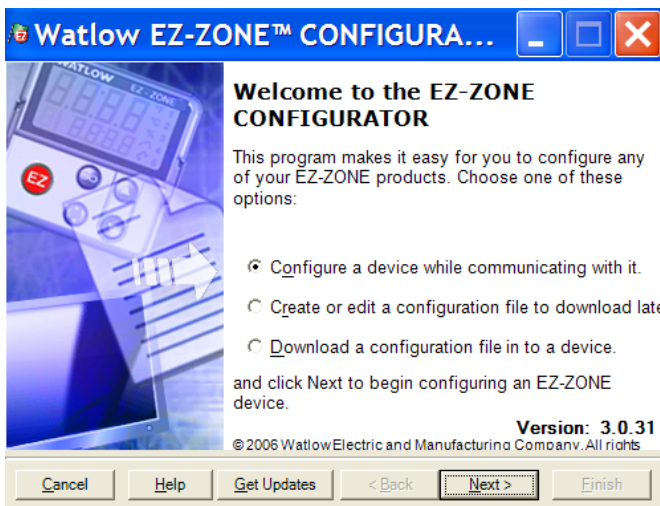

If the PC is already physically connected to the EZ-ZONE ST control click the next button to go on-line.

Note:

When establishing communications from PC to the EZ-ZONE ST control an interface converter will be required. The Standard Bus network uses EIA-485 as the interface. Most PCs today would require a USB to EIA-485 converter. However, some PCs may still be equipped with EIA-232 ports, therefore an EIA-232 to EIA-485 converter would be required.

As can be seen in the above screen shot the software provides the user with the option of downloading a previously saved configuration as well as the ability to create a configuration off-line to download later. The screen shots that follow will take the user on-line.

After clicking the next button above it is necessary to

define the communications port on the PC to use.

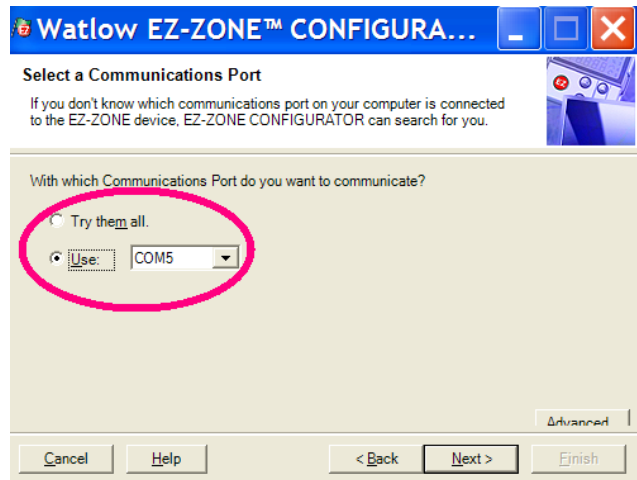

The available options allow the user to select "Try them all" or to use a specific known communications port. After installation of your converter if you are not sure which communications port was allocated select "Try them all" and then click next. The screen to follow shows that the software is scanning for devices on the network and that progress is being made.

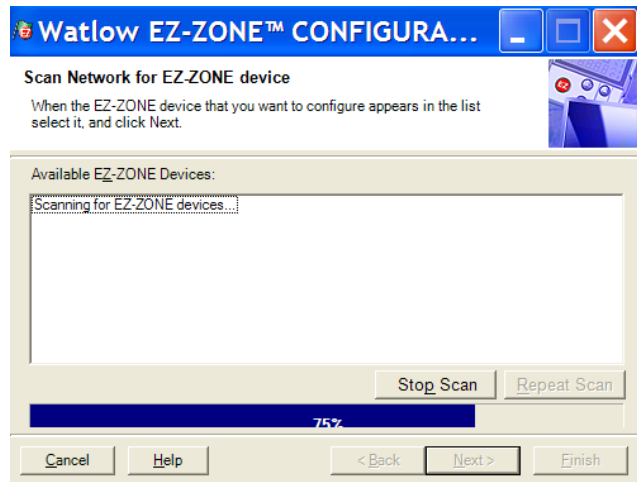

When complete the software will display all of the available devices found on the network as shown below.

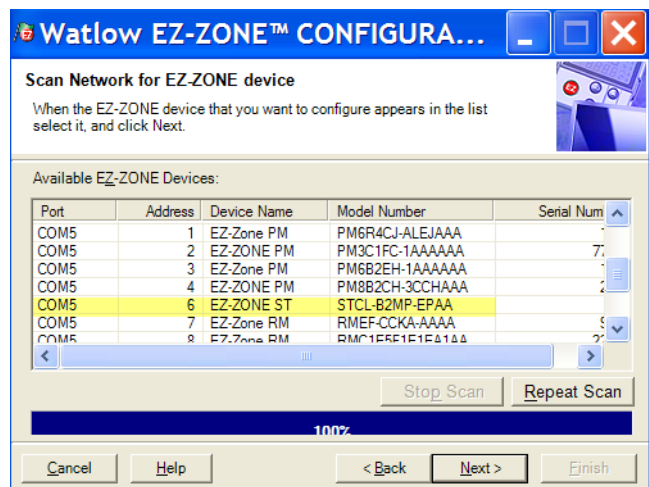

In the previous screen shot the ST is shown highlighted to bring greater clarity to the control in focus. Any EZ-ZONE device on the network will appear in this window and would be available for the purpose of configuration. After clicking on the control of choice simply click the next button once again. The next screen appears below.

to display the menu and parameter of choice. As an alternative, clicking on the negative symbol next to Setup will collapse the Setup Menu where the Operations Menu will appear next and perhaps deliver more clarity for the area of focus by not displaying unwanted menus and parameters. Once the focus is brought to an individual parameter (single click of

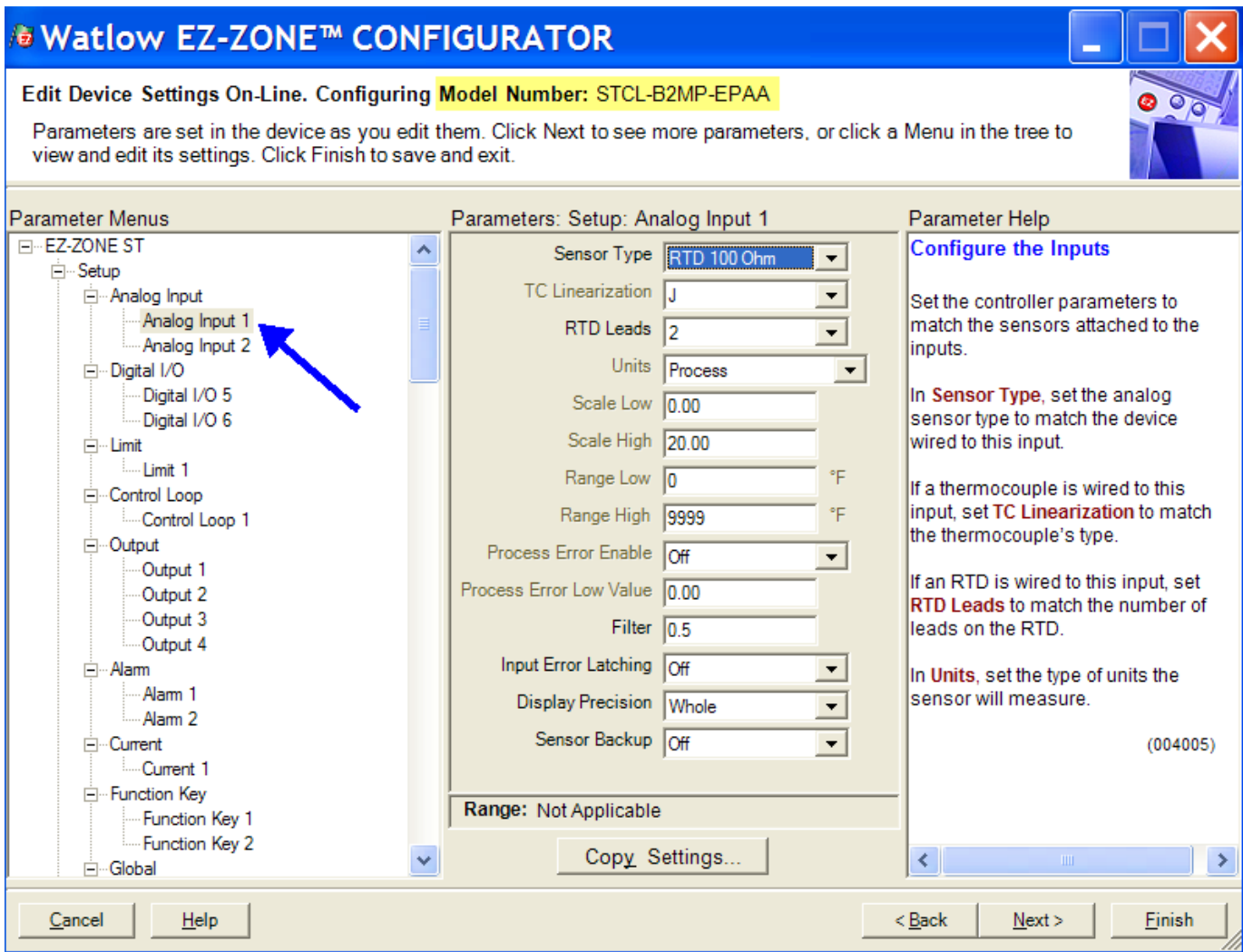

In the screen shot above notice that the device part number is clearly displayed at the top of the page (yellow highlight added for emphasis). When multiple EZ-ZONE devices are on the network it is important that the part number be noted prior to configuring so as to avoid making unwanted configuration changes to another control.

Looking closely at the left hand column (Parameter Menus) notice that it displays all of the available menus and associated parameters within the control. The menu structure as laid out within this software follows:

- Setup
- Operations
- Factory
- Profile

Navigating from one menu to the next is easy and clearly visible. Simply slide the scroll bar up or down

mouse) as is the case for Analog Input 1 in the left column, all that can be setup related to that parameter will appear in the center column. The grayed out fields in the center column simply mean that this does not apply for the type of sensor selected. As an example, notice that when RTD is selected, TC Linearization does not apply and is therefore grayed out. To speed up the process of configuration notice that at the bottom of the center column there is an option to copy settings. If Analog Input 1 and 2 are the same type of sensor click on "Copy Settings" where a copy from to copy to dialog box will appear allowing for quick duplication of all settings.

Notice too, that by clicking on any of those items in the center column that context sensitive help will appear for that particular item in the right hand column.

Lastly, when the configuration is complete click the "Finish" button at the bottom right of the previous screen shot. The screen that follows this action can be seen below.

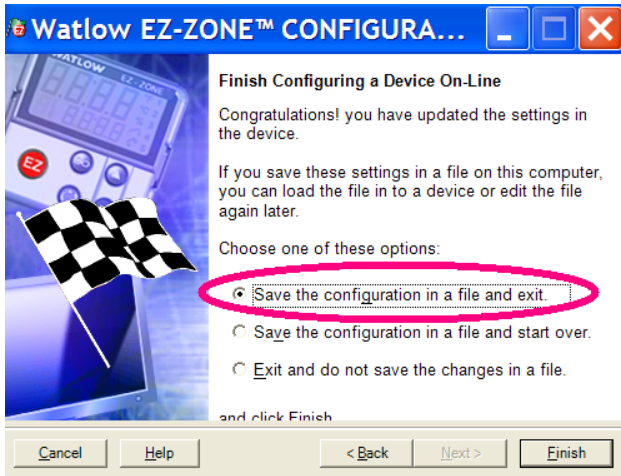

Although the ST control now contains the configuration (because the previous discussion focused on doing the configuration on-line) it is suggested that after the configuration process is completed that the user save this file on the PC for future use. If for some reason someone inadvertently changed a setting without understanding the impact it would be easy and perhaps faster to download a saved configuration back to the control versus trying to figure out what was changed.

Of course, there is an option to exit without saving a copy to the local hard drive.

After selecting Save above click the "Finish" button once again. The screen below will than appear.

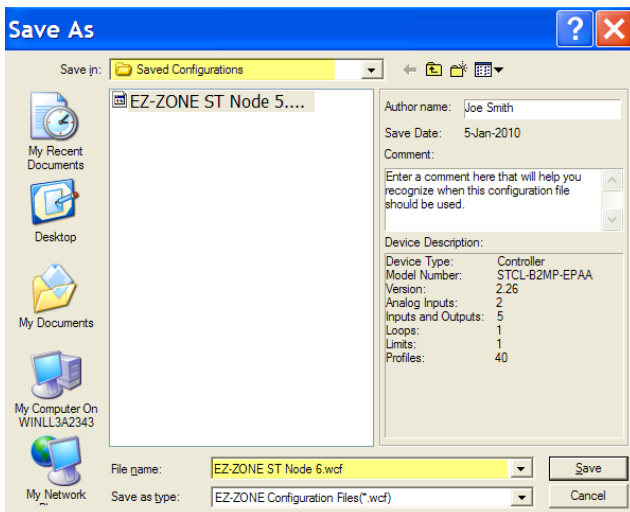

When saving the configuration note the location where the file will be placed (Saved in) and enter the file name (File name) as well. The default path for saved files follows:

```
\Program Files\Watlow\EZ-ZONE CONFIGURATOR\Saved Configurations
```

The user can save the file to any folder of choice.

8

Chapter 8: Appendix

Troubleshooting

Indication	Description	Possible Cause(s)	Corrective Action
Alarm won't clear or reset	Alarm will not clear or reset with keypad or digital input	<ul style="list-style-type: none"> Alarm latching is active Alarm set to incorrect output Alarm is set to incorrect source Sensor input is out of alarm set point range Alarm set point is incorrect Alarm is set to incorrect type Digital input function is incorrect 	<ul style="list-style-type: none"> Reset alarm when process is within range or disable latching. Set output to correct alarm source instance. Set alarm source to correct input instance. Correct cause of sensor input out of alarm range. Set alarm set point to correct trip point. Set alarm to correct type: process, deviation or power. Set digital input function and source instance.
Alarm won't occur	Alarm will not activate output	<ul style="list-style-type: none"> Alarm silencing is active Alarm blocking is active Alarm is set to incorrect output Alarm is set to incorrect source Alarm set point is incorrect Alarm is set to incorrect type 	<ul style="list-style-type: none"> Disable alarm silencing, if required. Disable alarm blocking, if required. Set output to correct alarm source instance. Set alarm source to correct input instance. Set alarm set point to correct trip point. Set alarm to correct type: process, deviation or power.
AL 1 Alarm Error AL 2	Alarm state cannot be determined due to lack of sensor input	<ul style="list-style-type: none"> Sensor improperly wired or open Incorrect setting of sensor type Calibration corrupt 	<ul style="list-style-type: none"> Correct wiring or replace sensor. Match setting to sensor used. Check calibration of controller.
	Sensor input below low alarm set point	<ul style="list-style-type: none"> Temperature is less than alarm set point Alarm is set to latching and an alarm occurred in the past Incorrect alarm set point Incorrect alarm source 	<ul style="list-style-type: none"> Check cause of under temperature. Clear latched alarm. Establish correct alarm set point. Set alarm source to proper setting.
	Sensor input above high alarm set point	<ul style="list-style-type: none"> Temperature is greater than alarm set point Alarm is set to latching and an alarm occurred in the past Incorrect alarm set point Incorrect alarm source 	<ul style="list-style-type: none"> Check cause of over temperature. Clear latched alarm. Establish correct alarm set point. Set alarm source to proper setting.
Er 1 Error Input Er 2	Sensor does not provide a valid signal to controller	<ul style="list-style-type: none"> Sensor improperly wired or open Incorrect setting of sensor type Calibration corrupt 	<ul style="list-style-type: none"> Correct wiring or replace sensor. Match setting to sensor used. Check calibration of controller.
Limit won't clear or reset	Limit will not clear or reset with keypad or digital input	<ul style="list-style-type: none"> Sensor input is out of limit set point range Limit set point is incorrect Digital input function is incorrect 	<ul style="list-style-type: none"> Correct cause of sensor input out of limit range. Set limit set point to correct trip point. Set digital input function and source instance.
L 1 Limit Error	Limit state cannot be determined due to lack of sensor input, limit will trip	<ul style="list-style-type: none"> Sensor improperly wired or open Incorrect setting of sensor type Calibration corrupt 	<ul style="list-style-type: none"> Correct wiring or replace sensor. Match setting to sensor used. Check calibration of controller.

Indication	Description	Possible Cause(s)	Corrective Action
L.L1 Limit Low L.L2	Sensor input below low limit set point	<ul style="list-style-type: none"> • Temperature is less than limit set point • Limit outputs latch and require reset • Incorrect alarm set point 	<ul style="list-style-type: none"> • Check cause of under temperature. • Clear limit. • Establish correct limit set point.
L.H1 Limit High L.H2	Sensor input above high limit set point	<ul style="list-style-type: none"> • Temperature is greater than limit set point • Limit outputs latch and require reset • Incorrect alarm set point 	<ul style="list-style-type: none"> • Check cause of over temperature. • Clear limit. • Establish correct limit set point.
LP.O1 Loop Open Error	Open Loop Detect is active and the process value did not deviate by a user-selected value in a user specified period with PID power at 100%.	<ul style="list-style-type: none"> • Setting of Open Loop Detect Time incorrect • Setting of Open Loop Detect Deviation incorrect • Thermal loop is open • Open Loop Detect function not required but activated 	<ul style="list-style-type: none"> • Set correct Open Loop Detect Time for application • Set correct Open Loop Deviation value for application • Determine cause of open thermal loop: misplaced sensors, load failure, loss of power to load, etc. • Deactivate Open Loop Detect feature
LP.R1 Loop Reversed Error	Open Loop Detect is active and the process value is headed in the wrong direction when the output is activated based on deviation value and user-selected value.	<ul style="list-style-type: none"> • Setting of Open Loop Detect Time incorrect • Setting of Open Loop Detect Deviation incorrect • Output programmed for incorrect function • Thermocouple sensor wired in reverse polarity 	<ul style="list-style-type: none"> • Set correct Open Loop Detect Time for application • Set correct Open Loop Deviation value for application • Set output function correctly • Wire thermocouple correctly, (red wire is negative)
rP Ramping	Controller is ramping to new set point	<ul style="list-style-type: none"> • Ramping feature is activated 	<ul style="list-style-type: none"> • Disable ramping feature if not required.
EUNE Autotuning	Controller is autotuning the control loop	<ul style="list-style-type: none"> • User started the autotune function • Digital input is set to start autotune 	<ul style="list-style-type: none"> • Wait until autotune completes or disable autotune feature. • Set digital input to function other than autotune, if desired.
No heat/cool action	Output does not activate load	<ul style="list-style-type: none"> • Output function is incorrectly set • Control mode is incorrectly set • Output is incorrectly wired • Load, power or fuse is open • Control set point is incorrect • Incorrect controller model for application 	<ul style="list-style-type: none"> • Set output function correctly. • Set control mode appropriately (Open vs Closed Loop). • Correct output wiring. • Correct fault in system. • Set control set point in appropriate control mode and check source of set point: remote, idle, profile, closed loop, open loop. • Obtain correct controller model for application.
No Display	No display indication or LED illumination	<ul style="list-style-type: none"> • Power to RUI (Remote User Interface) is off • Fuse open • Breaker tripped • Safety interlock switch open • Separate system limit control activated • Wiring error • Incorrect voltage to controller 	<ul style="list-style-type: none"> • Turn on power. • Replace fuse. • Reset breaker. • Close interlock switch. • Reset limit. • Correct wiring issue. • Apply correct voltage, check part number.
No Serial Communication	Cannot establish serial communications with the controller	<ul style="list-style-type: none"> • Address parameter incorrect • Incorrect protocol selected • Baud rate incorrect • Parity incorrect • Wiring error • EIA-485 converter issue • Incorrect computer or PLC communications port • Incorrect software setup • Termination resistor may be required 	<ul style="list-style-type: none"> • Set unique addresses on network. • Match protocol between devices. • Match baud rate between devices. • Match parity between devices. • Correct wiring issue. • Check settings or replace converter. • Set correct communication port. • Correct software setup to match controller. • Place 120 Ω resistor across EIA-485 on last controller.

Indication	Description	Possible Cause(s)	Corrective Action
Process doesn't control to set point	Process is unstable or never reaches set point	<ul style="list-style-type: none"> • Controller not tuned correctly • Control mode is incorrectly set • Control set point is incorrect 	<ul style="list-style-type: none"> • Perform autotune or manually tune system. • Set control mode appropriately (Open vs Closed Loop). • Set control set point in appropriate control mode and check source of set point: remote, idle, profile, closed loop, open loop.
Temperature runaway	Process value continues to increase or decrease past set point.	<ul style="list-style-type: none"> • Controller output incorrectly programmed • Thermocouple reverse wired • Controller output wired incorrectly • Short in heater • Power controller connection to controller defective • Controller output defective 	<ul style="list-style-type: none"> • Verify output function is correct (heat or cool). • Correct sensor wiring (red wire negative). • Verify and correct wiring. • Replace heater. • Replace or repair power controller. • Replace or repair controller.
100 Device Error rErr	Controller displays internal malfunction message at power up.	<ul style="list-style-type: none"> • Controller defective 	<ul style="list-style-type: none"> • Replace or repair controller.
hEr Heater Error	Heater Error	<ul style="list-style-type: none"> • Current through load is above current trip set point • Current through load is below current trip set point 	<ul style="list-style-type: none"> • Check that the load current is proper. Correct cause of overcurrent and/or ensure current trip set point is correct. • Check that the load current is proper. Correct cause of undercurrent and/or ensure current trip set point is correct.
CEr Current Error	Load current incorrect.	<ul style="list-style-type: none"> • Shorted solid-state or mechanical relay • Open solid-state or mechanical relay • Defective current transformer or controller • Noisy electrical lines 	<ul style="list-style-type: none"> • Replace relay. • Replace relay. • Replace or repair sensor or controller. • Route wires appropriately, check for loose connections, add line filters.
Menus inaccessible	Unable to access SEE , oPEr , FctY or PrOF menus or particular prompts in Home Page	<ul style="list-style-type: none"> • Security set to incorrect level • Digital input set to lockout keypad • Custom parameters incorrect 	<ul style="list-style-type: none"> • Check lockout setting in Factory Page. • Change state of digital input. • Change custom parameters in Factory Page.
EZ-Key doesn't work	EZ-Key does not activate required function	<ul style="list-style-type: none"> • EZ-Key function incorrect • EZ-Key function instance not correct • Keypad malfunction 	<ul style="list-style-type: none"> • Verify EZ-Key function in Setup Menu. • Check that the function instance is correct. • Replace or repair controller.
no upper display dEu lower display	The RUI (Remote User Interface) will not communicate with the controller at the selected zone.	<ul style="list-style-type: none"> • Communications wired incorrectly • Communications wires routed with power wires • Zone address set out of range • RUI or controller defective 	<ul style="list-style-type: none"> • Check and correct wiring. • Check and correct wiring. • Check zone range and address. • Replace or repair RUI or controller.
uRLU	Value cannot be displayed	<ul style="list-style-type: none"> • Scaling is out of range 	<ul style="list-style-type: none"> • Check scaling. • Call technical support.

Modbus - Programmable Memory Blocks

Assembly Definition Addresses and Assembly Working Addresses

Assembly Definition Addresses	Assembly Working Addresses	Assembly Definition Addresses	Assembly Working Addresses
40 & 41	200 & 201	80 & 81	240 & 241
42 & 43	202 & 203	82 & 83	242 & 243
44 & 45	204 & 205	84 & 85	244 & 245
46 & 47	206 & 207	86 & 87	246 & 247
48 & 49	208 & 209	88 & 89	248 & 249
50 & 51	210 & 211	90 & 91	250 & 251
52 & 53	212 & 213	92 & 93	252 & 253
54 & 55	214 & 215	94 & 95	254 & 255
56 & 57	216 & 217	96 & 97	256 & 257
58 & 59	218 & 219	98 & 99	258 & 259
60 & 61	220 & 221	100 & 101	260 & 261
62 & 63	222 & 223	102 & 103	262 & 263
64 & 65	224 & 225	104 & 105	264 & 265
66 & 67	226 & 227	106 & 107	266 & 267
68 & 69	228 & 229	108 & 109	268 & 269
70 & 71	230 & 231	110 & 111	270 & 271
72 & 73	232 & 233	112 & 113	272 & 273
74 & 75	234 & 235	114 & 115	274 & 275
76 & 77	236 & 237	116 & 117	276 & 277
78 & 79	238 & 239	118 & 119	278 & 279

Modbus Default Assembly Structure 40-79

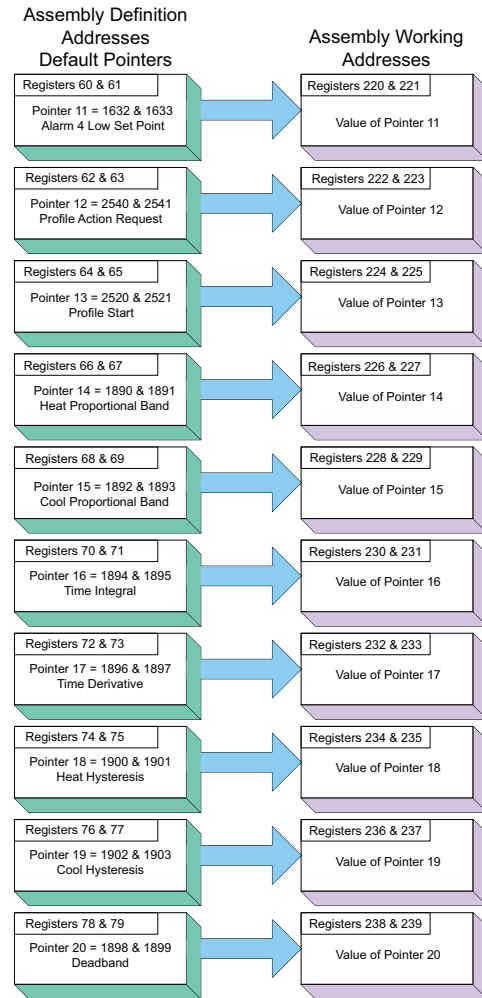
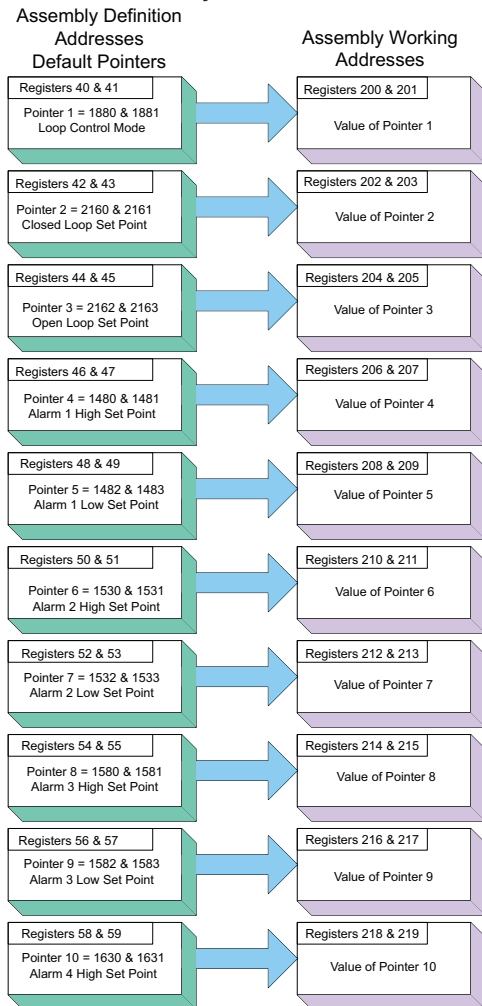

Modbus Default Assembly Structure 80-119

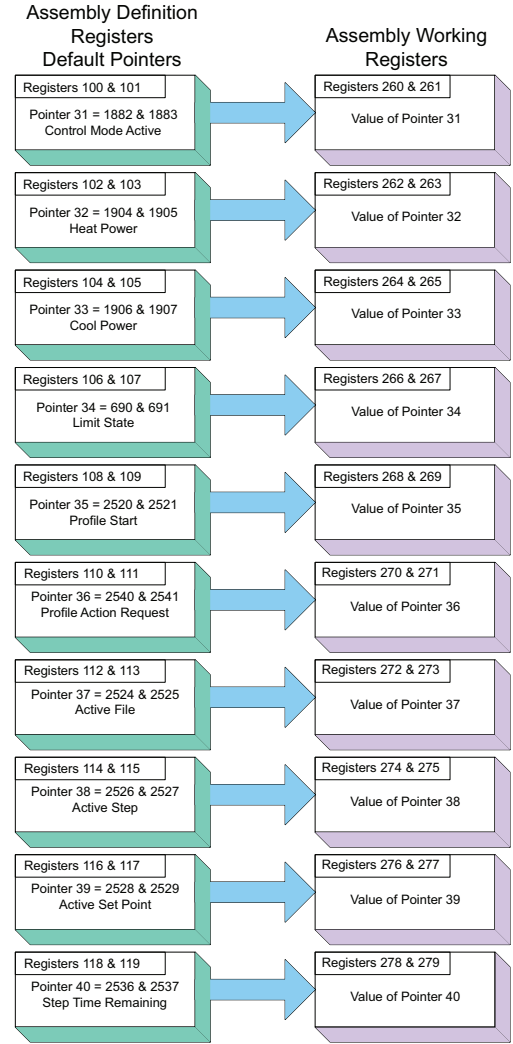
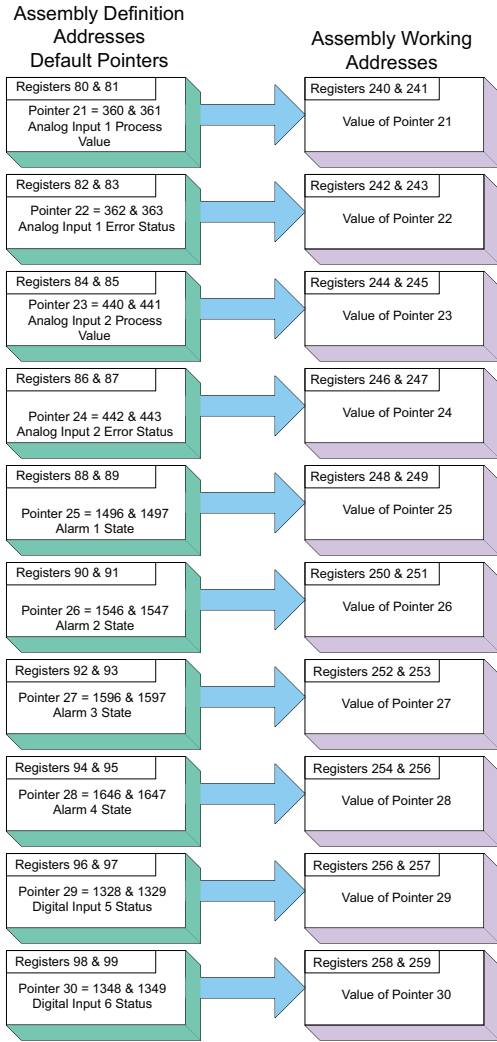

CIP Implicit O to T (Originator to Target) Assembly Structure

CIP Implicit Assembly Originator (Master) to Target (ST)					
Assembly Members	ST Assembly Class, Instance, Attribute	ST Data Type	Parameter	Parameter Class, Instance, Attribute	PLC Data Type
1	0x77, 0x01, 0x01	DINT	Loop Control Mode	0x97, 0x01, 0x01	DINT
2	0x77, 0x01, 0x02	DINT	Closed Loop Set Point	0x6B, 0x01, 0x01	REAL
3	0x77, 0x01, 0x03	DINT	Open Loop Set Point	0x6B, 0x01, 0x02	REAL
4	0x77, 0x01, 0x04	DINT	Alarm 1 - Alarm High Set Point	0x6D, 0x01, 0x01	REAL
5	0x77, 0x01, 0x05	DINT	Alarm 1 - Alarm Low Set Point	0x6D, 0x01, 0x02	REAL
6	0x77, 0x01, 0x06	DINT	Alarm 2 - Alarm High Set Point	0x6D, 0x02, 0x01	REAL
7	0x77, 0x01, 0x07	DINT	Alarm 2 - Alarm Low Set Point	0x6D, 0x02, 0x02	REAL
8	0x77, 0x01, 0x08	DINT	Alarm 3 - Alarm High Set Point	0x6D, 0x03, 0x01	REAL
9	0x77, 0x01, 0x09	DINT	Alarm 3 - Alarm Low Set Point	0x6D, 0x03, 0x02	REAL
10	0x77, 0x01, 0x0A	DINT	Alarm 4 - Alarm High Set Point	0x6D, 0x04, 0x01	REAL
11	0x77, 0x01, 0x0B	DINT	Alarm 4 - Alarm Low Set Point	0x6D, 0x04, 0x02	REAL
12	0x77, 0x01, 0x0C	DINT	Profile Action Request	0x7A, 0x01, 0x0B	DINT
13	0x77, 0x01, 0x0D	DINT	Profile Start	0x7A, 0x01, 0x01	DINT
14	0x77, 0x01, 0x0E	DINT	Heat Proportional Band	0x97, 0x01, 0x06	REAL
15	0x77, 0x01, 0x0F	DINT	Cool Proportional Band	0x97, 0x01, 0x07	REAL
16	0x77, 0x01, 0x10	DINT	Time Integral	0x97, 0x01, 0x08	REAL
17	0x77, 0x01, 0x11	DINT	Time Derivative	0x97, 0x01, 0x09	REAL
18	0x77, 0x01, 0x12	DINT	Heat Hysteresis	0x97, 0x01, 0x0B	REAL
19	0x77, 0x01, 0x13	DINT	Cool Hysteresis	0x97, 0x01, 0x0C	REAL
20	0x77, 0x01, 0x14	DINT	Dead Band	0x97, 0x01, 0x0A	REAL

CIP Implicit T to O (Target to Originator) Assembly Structure

CIP Implicit Assembly Target (ST) to Originator (Master)					
Assembly Members	ST Assembly Class, Instance, Attribute	ST Data Type	Parameter	Parameter Class, Instance, Attribute	PLC Data Type
1	Can not be changed	none	Device Status	none	DINT
2	0x77, 0x02, 0x01	DINT	Analog Input 1, Analog Input Value	0x68, 0x01, 0x01	REAL
3	0x77, 0x02, 0x02	DINT	Analog Input 1, Input Error	0x68, 0x01, 0x02	DINT
4	0x77, 0x02, 0x03	DINT	Analog Input 2, Analog Input Value	0x68, 0x02, 0x01	REAL
5	0x77, 0x02, 0x04	DINT	Analog Input 2, Input Error	0x68, 0x02, 0x02	DINT
6	0x77, 0x02, 0x05	DINT	Alarm 1, Alarm State	0x6D, 0x01, 0x09	DINT
7	0x77, 0x02, 0x06	DINT	Alarm 2, Alarm State	0x6D, 0x02, 0x09	DINT
8	0x77, 0x02, 0x07	DINT	Alarm 3, Alarm State	0x6D, 0x03, 0x09	DINT
9	0x77, 0x02, 0x08	DINT	Alarm 4, Alarm State	0x09, 0x04, 0x09	DINT
10	0x77, 0x02, 0x09	DINT	Event Status	0x6E, 0x01, 0x05	DINT
11	0x77, 0x02, 0x0A	DINT	Event Status	0x6E, 0x02, 0x05	DINT
12	0x77, 0x02, 0x0B	DINT	Control Mode Active	0x97, 0x01, 0x02	DINT
13	0x77, 0x02, 0x0C	DINT	Heat Power	0x97, 0x01, 0x0D	REAL
14	0x77, 0x02, 0x0D	DINT	Cool Power	0x97, 0x01, 0x0E	REAL
15	0x77, 0x02, 0x0E	DINT	Limit State	0x70, 0x01, 0x06	DINT
16	0x77, 0x02, 0x0F	DINT	Profile Start	0x74, 0x01, 0x01	DINT
17	0x77, 0x02, 0x10	DINT	Profile Action Request	0x74, 0x01, 0x0B	DINT
18	0x77, 0x02, 0x11	DINT	Current Profile	0x74, 0x01, 0x03	DINT
19	0x77, 0x02, 0x12	DINT	Current Step	0x74, 0x01, 0x04	DINT
20	0x77, 0x02, 0x13	DINT	Active Set Point	0x74, 0x01, 0x05	REAL
21	0x77, 0x02, 0x14	DINT	Step Time Remaining	0x74, 0x01, 0x09	REAL

Specifications

Line Voltage/Power

- 85 to 264V~ (ac), 47 to 63Hz
- 20 to 26V≈ (ac/dc), 47 to 63Hz
- 12VA maximum power consumption without mechanical contactor in system
- 50VA maximum power consumption with mechanical contactor in system
- 140VA maximum power consumption with external contactor
- Data retention upon power failure via nonvolatile memory

Environment (See Derating Curves in Declaration of Conformity)

- -18 to 70°C (0 to 158°F) operating temperature
- -40 to 85°C (-40 to 185°F) storage temperature
- 0 to 90 percent RH, non-condensing

Accuracy

- Calibration accuracy and sensor conformity: ±0.1 percent of span, ±1°C @ the calibrated ambient temperature and rated line voltage
 - Types R, S, B; 0.2%
 - Type T below -50°C; 0.2%
- Calibration ambient temperature: 25°C, ±3°C (77°F, ±5°F)
- Accuracy span: 540°C (1000°F) minimum
- Temperature stability: ±0.1°C/°C (±0.1°F/°F) rise in ambient maximum

Agency Approvals

- UL® 508 file E102269, cULus, CE, RoHS, W.E.E.E.
Product is UL recognized when purchased as components. Product is UL listed when purchased as a complete assembly.
- CSA approved C22.2#14 file 158031
- Limit version features FM approval

Controller

- Microprocessor-based, user-selectable control modes
- PID module: Single universal input, 2 outputs
- Limit module: Single universal input, 2 outputs
- Two additional digital input/outputs shared between PID and limit functions
- Control sampling rates: input 10 Hz, outputs 10 Hz
- Isolated EIA 485 Modbus® RTU serial communications

Wiring Termination Touch-Safe Terminals

- Input, power and controller output terminals touch safe removable 4 to 0.34 mm² (12 to 22 AWG), 7.0 lb-in. torque.
- Power load terminals 3.3 to 0.324 mm² (6 to 12 AWG) STR 90°C (194°F) copper conductor only, 3.96 Nm (35 lb-in) torque
- Temperature rating for line and lug loads 90°C (194°F)

Universal Input

- Thermocouple, grounded or ungrounded sensors
- RTD 2- or 3-wire, platinum, 100 Ω @ 0°C calibration to DIN curve (0.00385 Ω/Ω°C)
- Process, 0 to 20 mA @ 100 Ω, or 0 to 10V≈ (dc) @ 20 kΩ input impedance; scalable, 0 to 50 mV
- Inverse scaling
- >20 MΩ input impedance
- Maximum of 20 kΩ source resistance
- Maximum of 20 Ω lead resistance for an RTD
- 42V≈ (dc) isolation voltage for input 2

Digital Input

- Update rate 1 Hz
- Dry contact or dc voltage

DC voltage

- Maximum input 36V at 3 mA
- Minimum high state 3V at 0.25 mA
- Maximum low state 2V

Dry contact

- Maximum short circuit 13 mA
- Minimum open resistance 500 Ω

- Maximum closed resistance 100 Ω

Current Measurement

- Nominal operating frequency 50 to 60 Hz.
- Accuracy ±15% of displayed value
- Accuracy range 5 to 50 A
- Operating range 2 to 50 A

Digital Output

- Update rate 10 Hz
- Output voltage 24V, current limit 10 mA

Input Accuracy Span Ranges

- Type J: 0 to 815°C or 32 to 1500°F
- Type K: -200 to 1370°C or -328 to 2500°F
- Type T: -200 to 400°C or -328 to 750°F
- Type N: 0 to 1300°C or 32 to 2372°F
- Type E: -200 to 800°C or -328 to 1470°F
- Type C: 0 to 2315°C or 32 to 4200°F
- Type D: 0 to 2315°C or 32 to 4200°F
- Type F: 0 to 1395°C or 32 to 2543°F
- Type R: 0 to 1760°C or 32 to 3200°F
- Type S: 0 to 1760°C or 32 to 3200°F
- Type B: 0 to 1816°C or 32 to 3300°F
- RTD (DIN): -200 to 800°C or -328 to 1472°F
- Process: -1999 to 9999 units

Output Hardware

- User selectable for heat-cool as on-off, P, PI, PD, PID, alarm or limit action.
- Output 1: SSR drive 20 to 28V≈ (dc) low side open collector switch
- Output 2: SSR, Form A, 0.5 A @ 24V~ (ac) minimum, 264V~ (ac) maximum, optically isolated, without contact suppression
- Output 4: Electromechanical relay. Form A, rated 2 A, 125VA, pilot duty, 120/240V~ (ac); 25VA, 24V~ (ac)
- Output 2: Electromechanical relay. Form A, rated 5 A, 125VA, pilot duty, 120/240V~ (ac); 25VA, 24V~ (ac)
- Output 3: Electromechanical relay. Form C, rated 5 A, 125VA, pilot duty, 120/240V~ (ac); 25VA, 24V~ (ac)

Weight:

- 40 A heat sink assembly only, 431 g (0.95 lb)
- 25 A heat sink assembly only, 340 g (0.75 lb)
- solid-state relay controller only, 177 g (0.39 lb)
- solid-state relay controller only with base without heat sink, 345g (0.76 lb)
- full system with 25 A heat sink, 1.134 kg (2.5 lb)

Note:

These specifications are subject to change without prior notice.

Ordering Information

Model Numbers for EZ-ZONE® ST

EZ-ZONE ST Integrated Control Loop

ST - - - - -

- Output 1 is dedicated to controlling the internal SSR.
- If 75A heat sink is selected below 1 Digital Input (6) will be factory set and fixed as the SSR over temperature Digital Input.

Output 2, Digital I/O and Current Measurement

- K 0.5 A solid-state relay
- B 0.5 A solid-state relay with 2 digital i/o points
- P 0.5 A solid-state relay with current measurement
- E 0.5 A solid-state relay with 2 digital i/o points and current measurement
- H 5 A mechanical relay form A
- D 5 A mechanical relay form A, 2 digital i/o points
- J 5 A mechanical relay form A, current measurement
- C 5 A mechanical relay form A, 2 digital i/o points, current measurement

Integrated Limit Controller

1 universal input and 2 outputs

- A None
- L Limit control module (output 3, 5A, Form C mech. relay; output 4, 2A, Form A mech. relay)
- B Terminal block access to mechanical contactor coil contacts

Mechanical Contactor and Power Supply

If the limit controller was ordered, the contactor will come internally connected to output 4 on the limit module. The contactor has external contacts available for daisy chaining to other branch circuit components.

- AH No contactor and universal high voltage power supply 100 to 240V \approx (ac/dc)
- AL No contactor and universal low voltage power supply 24 to 28V \approx (ac/dc)
- B1 Single pole, 40 A Watlow contactor, 24V \sim (ac) power supply
- B2 Single pole, 40 A Watlow contactor, 110 / 120V \sim (ac) power supply
- B3 Single pole, 40 A Watlow contactor, 208 / 240V \sim (ac) power supply
- F1 Dual pole, 40 A Watlow contactor, 24V \sim (ac) power supply
- F2 Dual pole, 40 A Watlow contactor, 110 / 120V \sim (ac) power supply
- F3 Dual pole, 40 A Watlow contactor, 208 / 240V \sim (ac) power supply

Communications

- A Standard software to connect to pc software, remote user interface (RUI) and other EZ-ZONE devices
- M Modbus™ RTU communication port to connect to non-ST products

Solid-State Relay

- B = Zero Cross 10 A, 24 to 240V \sim (ac) output
- C = Zero Cross 25 A, 24 to 240V \sim (ac) output
- D = Zero Cross 40 A, 24 to 240V \sim (ac) output
- *E = Zero Cross 50 A, 24 to 240V \sim (ac) output
- *K = Zero Cross 75 A, 24 to 240V \sim (ac) output
- *F = Zero Cross 90 A, 24 to 240V \sim (ac) output
- G = Zero Cross 25 A, 48 to 600V \sim (ac) output
- H = Zero Cross 40 A, 48 to 600V \sim (ac) output
- *L = Zero Cross 75A, 48 to 600V \sim (ac) output
- *J = Zero Cross 90A, 48 to 600V \sim (ac) output
- M = Phase Angle 25A, 100 to 240V \sim (ac) output
- N = Phase Angle 40A, 100 to 240V \sim (ac) output
- *P = Phase Angle 75A, 100 to 240V \sim (ac) output
- R = Phase Angle 25A, 260 to 600V \sim (ac) output
- S = Phase Angle 40A, 260 to 600V \sim (ac) output
- *T = Phase Angle 75A, 260 to 600V \sim (ac) output

*EZ-ZONE ST contactor rated @ 40A maximum.

Heat Sinks

- A = None (no DIN-rail mount)
- B = 25A
- C = 40A
- D = 75A, 24V \approx (dc) fan cooled
- E = 75A, 115V \sim (ac) fan cooled
- F = 75A, 240V \sim (ac) fan cooled

Note: If heat sink option D, E or F is selected the integrated PID controller options B, E, D or C must also be ordered. The 75A heat sink includes an SSR over-temperature thermostat shut-down feature factory connected to Digital Input 6.

Firmware

- A Standard Watlow
- P Profile ramp and soak (4 profiles, 40 steps)
- S Custom

Customization (logo, parameters, hardware, firmware)

- AA Standard
- XX {letters to be determined, consult factory}

EZ-ZONE ST Replacement Modules

STRC - 0

STRC-0 (Series ST Replacement Control Module)

- Output 1 is dedicated to controlling the internal Solid-State Relay.
- Includes 1 universal input and 2 outputs for heat, cool or alarm

Output 2, Digital I/O and Current Measurement

- K 0.5 A solid-state relay
- B 0.5 A solid-state relay with 2 digital i/o points
- P 0.5 A solid-state relay with current measurement
- E 0.5 A solid-state relay with 2 digital i/o points and current measurement
- H 5 A mechanical relay form A
- D 5 A mechanical relay form A, 2 digital i/o points
- J 5 A mechanical relay form A, current measurement
- C 5 A mechanical relay form A, 2 digital i/o points, current measurement

Integrated Limit Controller 1 universal input and 2 outputs

- A None
- L Limit control module (output 3, 5A, Form C mech. relay; out. 4, 2A, Form A mech. relay)
- B Terminal block access to mechanical contactor coil contacts

Power Supply for Mechanical Contactor L - For use with mechanical contactor options AL, B1 and F1
H - For use with mechanical contactor options AH, B2, B3, F2 and F3

- L Low voltage power supply 24 to 28V \approx (ac/dc)
- H High voltage power supply 100 to 240V \approx (ac/dc)

Communications

- A Standard software to connect to pc software, remote user interface (RUI) and other EZ-ZONE devices
- M Modbus™ RTU communication port to connect to non-ST products

Firmware

Options	Original Model Includes a Phase Angle SSR SSR = M, N, P, R, S or T	Original Model Includes a 75A Heat Sink Heat Sink = D, E or F	Original Model Includes Profile Ramp & Soak Firmware = P
B =	No	No	No
C =	No	No	Yes
D =	No	Yes	No
E =	Yes	No	No
F =	Yes	Yes	No
G =	No	Yes	Yes
H =	Yes	No	Yes
J =	Yes	Yes	Yes

Customization (logo, parameters, hardware, firmware)

- AA Standard
- XX {letters to be determined, consult factory}

Ordering Information for EZ-ZONE ST Replacement Base

Code Number **S** **T** **R** **T** - **B** **A** **S** **E** - _ _ _ _

Series ST Replacement Base

Integrated Mechanical Controller

- 0000 Compact base version (no space for mechanical contactor)
- DPB1 Base housing with single-pole, 40 A Watlow contactor, 24V~ (ac) power supply
- DPB2 Base housing with single-pole, 40 A Watlow contactor, 110/120V~ (ac) power supply
- DPB3 Base housing with single-pole, 40 A Watlow contactor, 208/240V~ (ac) power supply
- DPF1 Base housing with dual-pole, 40 A Watlow contactor, 24V~ (ac) power supply
- DPF2 Base housing with dual-pole, 40 A Watlow contactor, 110/120V~ (ac) power supply
- DPF3 Base housing with dual-pole, 40 A Watlow contactor, 208/240V~ (ac) power supply

Ordering Information for EZ-ZONE® ST Replacement Heat Sink

Code Number **S** **T** **R** **T** - **H** **S** - _ _ _ 0 0 0 _

Series ST Replacement Heat Sink

Heat Sink Base Configuration (Integrated Mechanical Contactor)

- AA Heat sink for mounting to compact base with no mechanical contactor
(ordered separately STRT-BASE- _ _ _ _)
- CB Heat sink for mounting to large base with integrated mechanical contactor
(base and contactor ordered separately under STRT-BASE- _ _ _ _)

Heat Sink Amperage Rating

- B 25A
- C 40A
- D 75A 24V= (dc) fan cooled
- E 75A 115V~ (ac) fan cooled
- F 75A 240V~ (ac) fan cooled

Ordering Information for EZ-ZONE ST Replacement Solid State Relays (SSRs)

- 0003-0214-0000 Zero Cross 10A and 25A replacement (24 to 240V~ (ac) output)
- 0003-0215-0000 Zero Cross 40A and 50A replacement (24 to 240V~ (ac) output)**
- 0802-0952-0000 Zero Cross 75A and 90A replacement (24 to 240V~ (ac) output)**
- 0003-0216-0000 Zero Cross 25A replacement (48 to 600V~ (ac) output)
- 0003-0217-0000 Zero Cross 40A replacement (48 to 600V~ (ac) output)
- 0802-0951-0000 Zero Cross 75A and 90A replacement (48 to 600V~ (ac) output)**
- 0003-0256-0001 Phase Angle 25A (100-240V~ (ac) output)
- 0003-0256-0002 Phase Angle 40A (100-240V~ (ac) output)
- 0003-0256-0005 Phase Angle 75A (100-240V~ (ac) output)**
- 0003-0256-0003 Phase Angle 25A (260-600V~ (ac) output)
- 0003-0256-0004 Phase Angle 40A (260-600V~ (ac) output)
- 0003-0256-0006 Phase Angle 75A (260-600V~ (ac) output)**

** EZ-ZONE ST contactor rated for maximum 40A

Index

- AbL** Alarm Blocking 49, 73
- ACLF** AC Line Frequency 52, 71
- AdSP** Alarm Display 50
- Rh_i** Alarm High Set Point 35, 72
- Rh_y** Alarm Hysteresis 49, 72
- A_i** Analog Input Menu 31, 40
- A_{iS}** Alarm Source Instance 49
- ALR** Alarm Latching 49, 72
- AL_g** Alarm Logic 49
- ALM₇** Alarm Menu 35, 48
- AL_o** Alarm Low Set Point 35, 72
- AS_d** Alarm Sides 49
- AS_i** Alarm Silencing 49, 73
- AtSP** Autotune Set Point 33, 65
- Att_o** Attention 72, 73
- At_y** Alarm Type 48, 72
- AUT_E** Autotune 33, 65
- BAUD** Baud Rate 53
- bPLS** 68
- CR_g** Cool Algorithm 44, 69
- CR_L** Calibration Menu 63
- CE_r** Current Error 36
- C_F** Display Units 52, 53
- Ch_i** Current High Set Point 36
- Ch_y** Cool Hysteresis 34, 69
- CL_o** Current Low Set Point 36
- CL_r** Clear 72
- CM₇** Control Mode 33, 69
- CM_{7A}** Control Mode Active 32
- Code** Public Key 62
- Code** Unlock Code 74
- COM₇** Communications Menu 53
- CP_b** Cool Proportional Band 34, 65, 70
- CP_r** Cool Power 33, 65
- CSP** Closed Loop Set Point 33
- CSP** Closed Loop Working Set Point 33
- CU_r** Current Read 36
- CU_{rr}** Current Menu 36, 50
- CUSE** Custom Setup 60
- DATE** Date of Manufacture 62
- db** Dead Band 34, 70
- DEC** Decimal 42
- di_{AG}** Diagnostics Menu 62
- di_o** Digital Input/Output Menu 42
- dir** Direction 42
- do_S** Digital Output State 32
- dPrS** Display Pairs 52
- E_{iS}** Event Input Status 32
- EL_{io}** Electrical Input Offset 63, 67
- EL_{iS}** Electrical Input Slope 63, 67
- EL_{oo}** Electrical Output Offset 63
- EL_{oS}** Electrical Output Slope 63
- End** End 58
- End** End Type 56
- Ent₁** Active Event Output 1 38
- Ent₁** Event Output 1 57
- Ent₂** Event Output 2 57
- FR_{iL}** Input Error Failure 45, 68
- F_i** Digital Output Function Instance 42, 44
- F_i** Output Function Instance 47
- F_{iL}** Filter 41
- F_{iL}** Filter Time 67
- F_o** Output Function 47, 48
- FUn** Function Key Menu 51
- GLbL** Global Menu 52
- gS_d** Guaranteed Soak Deviation 52
- gSE** Guaranteed Soak Enable 52
- h_{AG}** Heat Algorithm 44, 69
- h_{Er}** Heater Error 36
- h_{h_y}** Heat Hysteresis 34, 69
- hour** Hours 55
- hP_b** Heat Proportional Band 34, 65, 70
- hP_r** Heat Power 33, 65
- hSP** Control Loop High Set Point 47
- i_{CR}** Calibration Offset 31, 66–67
- id_S** Idle Set Point 33
- i_{Er}** Input Error Latching 42
- i_{Er}** Input Error Status 31
- iPF₄** IP Fixed Address Part 4 52
- J_C** Jump Count 56
- J_C** Jump Count Remaining 38
- J_S** Jump Step 56
- L_{dd}** Open Loop Detect Deviation 46
- L_{dE}** Open Loop Detect Enable 46
- L_{dt}** Open Loop Detect Time 46
- Lh_y** Limit Hysteresis 44
- L_{iM₇}** Limit Menu 32, 44
- L_{i_n}** Linearization 40
- LL_S** Limit Low Set Point 32
- Lo_C** Security Setting Menu 60, 62
- Lo_{CL}** Locked Access Level 74
- Lo_{CL}** Locked Access Level 74
- Lo_{CL}** Locked Access Level 61
- Lo_{Lo}** Lock Operations page 73
- Lo_{Lo}** Lock Operations Page 60, 73
- Lo_{CP}** Lock Profiling Page 61, 62, 73
- LoOP** Control Loop Menu 44
- LoOP** Loop Menu 33
- LS_d** Limit Sides 44
- LS_P** Loop Low Set Point 46
- MAN₇** 68
- MAN₇** Manual Power 46
- MAN₇** Modbus Word Order 53
- MAN₇** Minutes 55
- MAN₇** Monitor Menu 32
- MAN₇** Electrical Measurement 63, 67
- nVS** Non-volatile Save 53
- o_{CE}** Output Control 42, 47
- o_{Fn}** Output Function 66
- o_{h_i}** Output High Power Scale 43, 48
- o_{Lo}** Output Low Power Scale 43, 48
- oP** Open Loop Set Point 34
- o_{tb}** Output Time Base 43, 48
- o_{TP_E}** Output Menu 47
- PAR** Parity 53
- PASS_A** Administrator Password 62, 74
- PASS_A** Administrator Password 74
- PASS_E** Password Enable 61
- PASS_E** Password Security Enable 73
- PASS** Password 62, 74
- PASS_u** User Password 61, 74
- PASS_u** User Password 74
- PEE** Process Error Enable 41
- PEL** Process Error Low 41
- PS_{EA}** Profile Status Menu 37
- PT_{YP}** Profile Type 52
- Pu_A** Process Value Active 33
- r_{ATE}** Rate 55, 57
- r_{h_i}** Range High 41, 68
- r_{Lo}** Range Low 41, 42, 68
- rLo_{Lo}** Read Lockout Security 61, 73
- roLL** Rolling Password 61, 74
- roLL** Rolling Password 74
- rP** Ramp Action 46, 71
- r_{rt}** Ramp Rate 46, 71
- r_{SC}** Ramp Scale 46, 71
- r_{EL}** RTD Leads 40
- SbL_d** Software Build 62
- SEC** Seconds 55
- SE_n** Sensor Type 40, 66, 68
- SFn_A** Source Function A 48
- Sh_i** Scale High 41, 68
- S_{i_d}** Software ID 62
- S_{iL}** Silence 72
- S_{Lo}** Scale Low 41, 68
- SLo_{Lo}** Set Lockout Security 61, 73
- S_n** Serial Number 62
- SP_{h_i}** Set Point High Limit Open Loop 47
- SP_{Lo}** Set Point Low Limit Open Loop 47
- S_{rL}** Software Release 62
- SS_{t_i}** Soft Start Time 39, 48

SEI Step Time Remaining 37, 38
SEP Active Step 37
SEYP Active Step Type 37
SEYP Step Type 55
TAGR User Tune Aggressiveness 45, 65
tband TRU-TUNE+™ Band 45, 66
td Time Derivative 34, 65, 70
tgn TRU-TUNE+™ Gain 45, 66
t Time 57
t Time Integral 34, 65, 70
t.tun TRU-TUNE+™ Enable 45, 66
UFA User Failure Action 45
ULoc Unlock 74
ULoc Unlock 59
ULoc Unlock Menu 74
USr.r User Restore Set 52, 65
USr.S User Save Set 52, 65
USEP Unused Step 58
WJE Wait For Event 57
WJE.1 Wait Event 1 56
WJPr Wait For Process 57
AL 1 Alarm Error 79
AL 2 Alarm Error 79
CEr Current Error 81
Er.2 Error Input 2 79
Er.1 Error Input 1 79
hEr Heater Error 81
L.PP Limit Error 79
rP Ramping 80
tUNE Autotuning 80
uARLU 81

A

AC Line Frequency 52, 71
 Active Event Output (1 or 2) 38
 Active Step 37
 Active Step Type 37
 adaptive tuning 66
 address
 Modbus 26
 Address Modbus 53
 Address Standard Bus 53
 Administrator Password 62, 74
 agency approvals 3, 85
 alarm blocking 73
 Alarm Menu 35, 48
 alarms 72
 Blocking 49, 73
 deviation 72
 Display 50
 Hysteresis 49, 72
 Latching 49, 72
 Logic 49
 process 72
 set points 72
 Sides 49

Silencing 49, 73
 Source 48
 Type 48
 Alarm Type 72
 analog input 4
 Analog Input Menu 31, 40
 Assembly Definition
 Addresses 82
 Assembly Definition Addresses 75
 Assembly Definition Addresses and
 Assembly Working Addresses 82
 Assembly Working Addresses 75, 82
 auto (closed loop) control 68
 Autotune 65
 Autotune Aggressiveness 45
 Autotune Request 33
 Autotune Set Point 33, 65
 autotuning 65–66
 autotuning with TRU-TUNE+™ 66

B

Baud Rate 53
 Baud 26
 Blocking 49, 73
 bumpless transfer 68

C

calibrating an analog input 67
 Calibration Menu 63
 Calibration Offset 31, 66–67
 chattering output 69
 CIP - Communications Capabilities 75
 CIP Communications Methodology 29
 CIP Implicit O to T (Originator to Target) Assembly Structure 75, 84
 CIP Implicit T to O (Target to Originator) Assembly Structure 84
 Closed Loop Set Point 33
 Closed Loop Working Set Point 33
 Communication Protocols 28
 Communications Menu 53
 conceptual view 4
 Control 42, 47
 Control Loop Menu 44
 control methods 68
 Control Mode 33, 69
 Control Mode Active 32
 Control Module Factory Page 59
 Control Module Menus
 Factory Page
 Calibration Menu 63
 Custom Setup Menu 60
 Diagnostics Menu 62
 Security Setting Menu 60, 62

Operations Page

Alarm Menu 35
 Analog Input Menu 31
 Current Menu 36
 Digital Input/Output Menu 32
 Limit Menu 32
 Loop Menu 33
 Monitor Menu 32
 Profile Status Menu 37

Setup Page

Alarm Menu 48
 Analog Input Menu 40
 Communications Menu 53
 Control Loop Menu 44
 Current Menu 50
 Digital Input/Output Menu 42
 Global Menu 52
 Limit Menu 44
 Output Menu 47

Cool Algorithm 44, 69
 Cool Hysteresis 34, 69
 Cool Power 33, 65
 Cool Proportional Band 34, 65, 70
 Current Error 36
 Current Menu 36, 50
 Custom Setup Menu 60

D

Data Map 53
 Date of Manufacture 62, 63
 dead band 70
 Dead Band 34, 70
 Decimal 42
 deviation alarms 72
 Diagnostics Menu 62
 digital input 4
 Digital Input Function 51
 Digital Input/Output Menu 32, 42
 Direction 42
 Display 50
 Display Pairs 52
 Display Units 52, 53

E

Electrical Gain 67
 Electrical Input Offset 63, 67
 Electrical Input Slope 63, 67
 Electrical Measurement 63, 67
 Electrical Output Offset 63
 Electrical Output Slope 63
 End 58
 End Set Point Value 56
 Event Output (1 and 2) 57, 58
 EZ-ZONE™ ST
 without contactor 6, 8
 EZ-ZONE™ ST
 without contactor 7
 with contactor 7

EZ Key 4

F

Factory Page

Control Module 59

features and benefits 3

Filter Time 41, 67

filter time constant 67

Function 66

Function Instance 42, 44

functions 4

G

Global Menu 52

Guaranteed Soak Deviation 52

Guaranteed Soak Enable 52

H

Heat Algorithm 44, 69

Heater Error 36

Heat Hysteresis 34, 69

Heat Power 33, 65

Heat Proportional Band 34, 65, 70

High Power Scale 43, 48

high range 68

high scale 68

High Set Point

Alarm 35, 36, 72

Current 36

Loop 47, 68

Hours 55

Hysteresis 44, 49, 72

I

Idle Set Point 33

Input Error Failure 45, 68

Input Error Latching 42, 69

Input Error Status 31

input features 66–68

calibration 67

Input Sensor Type 66

Instance 51

Integrate 44

input events 4

instance, defined 4

IP Fixed Address Part 4 52

J

Jump Count 56

Jump Count Remaining 38

Jump Step 56

K

L

labels. *See* sub-assembly labels

Latching 49, 72

Limit Menu 32, 44

Linearization 40

Locked Access Level 61, 74

Lock Operations Page 73

Lockout Menu 73

Lock Profiling Page 73

Logic 49

Loop Menu 33

Low Power Scale 43, 48

low range 68

low scale 68

Low Set Point

Alarm 35, 72

Current 36

Limit 32

Loop 46, 68

M

Manual Control Indicator Light 69

manual (open loop) control 68

manual tuning 65

Minutes 55

Modbus Default Assembly Structure
40-79 82

Modbus Default Assembly Structure
80-119 83

Modbus - Programmable Memory
Blocks 82

Modbus Register Mapping 39

Modbus RTU & Modbus TCP Proto-
cols 28

Modbus - Using Programmable
Memory Blocks 75

Modbus Word Order 53

model numbers 86

Monitor Menu 32

mounting and unmounting from a
DIN rail 14

N

National Electric (NEC) 9–10

network wiring 25

Non-volatile Save 39, 53

Non-Volatile Save 26

O

on-off control 69

Open Loop Detect Deviation 46

Open Loop Detect Enable 46

Open Loop Detect Time 46

Open Loop Set Point 34

Operations Page

Control Module 30

ordering information

replacement base 88

replacement heat sink 88

replacement solid state relays
(SSRs) 88

output configuration 68

output features 68

Output Menu 47

outputs 4

Output State 32

P

Parameter 1 to 20 60

Parity 26, 53

Password 59, 62, 74

Password Security Enable 73

Peltier Delay 39

Phase Angle 71

process alarms 72

Process Error Enable 41

Process Error Low 41

Process Value 31

Process Value Active 33

Profibus DP 29

Profile Status Menu 37

Profile Type 52

Profiling Page 54

profiling parameters 54

programming the Home Page 65

proportional control 69

plus integral (PI) control 70

plus integral plus derivative (PID)
control 70

Public Key 59, 62

Q

R

Ramp Action 46

Ramp Rate 46, 71

Ramp Scale 46, 71

Range High 41, 68

Range Low 41, 42, 68

Rate 55, 57

Read 36

Read Lockout Security 73

Remote User Interface. *See* RUI

replacing the solid-state relay 15–16

restoring user settings 65

Rolling Password 61, 74

RTD Leads 40

S

saving user settings 65

Scale High 41, 68

Scale Low 41, 68

Seconds 55

secure settings 73, 74

Security Setting 60, 62

sensor selection 67

Sensor Type 40, 66, 68

Serial Number 62

Set Lockout Security 73

set point high limit 68

Set Point High Limit Open Loop 47

set point low limit 68

Set Point Low Limit Open Loop 47

- Setup Page
 - Control Module 39
- Sides
 - Alarm 49
 - Limit 44
- Silencing 49, 73
- single set point ramping 71
- Soft Start 71
- Soft Start Time 71
- Software Build 62
- Software Configuration 76
- Software ID 62
- Software Release 62
- Source 48
- specifications 85
- status indicator light 9
- Step Type 55
- sub-assembly labels 13
- System Security 74

T

- thermal system control 3
- Time 57
- Time Base 43, 48
- Time Derivative 34, 65, 70
- Time Integral 34, 65, 70
- troubleshooting 79
- TRU-TUNE+™ Band 45, 66
- TRU-TUNE+™ Enable 45, 66
- TRU-TUNE+™ Gain 45, 66
- tuning the PID parameters 65
- Type 48

U

- Unlock 74
- Unlock Code 74
- Unused Step 58
- User Failure Action 45
- User Password 61, 74
- User Programmable Memory Blocks 28
- User Restore Set 52, 65
- User Save Set 52, 65
- User Tune Aggressiveness 65
- Using EZ-ZONE® Configurator Software 76
- using the software 73

V

- variable time base 71

W

- Wait Event (1 and 2) 56
- Wait For Event 57
- Wait For Process 57
- wiring
 - output 4 mechanical relay, form A 23
- wiring 7–14

- input 1 process 18
- input 1 RTD 18
- input 1 thermocouple 18
- input 2 process 19
- input 2 RTD 19
- input 2 thermocouple 19
- Modbus RTU or standard bus EIA-485 communications 24
- output 1 solid-state relay without a contactor 21
- output 1 solid-state relay with a contactor 20
- output 2 mechanical relay, form A 22
- output 2 solid-state relay, form A 22
- output 3 mechanical relay, form C 22
- output 4 mechanical relay, form A 22
- power 18
- standard bus EIA-485 communications 24
- without a contactor 10
- with a contactor 9
- wiring a network 25

X

Y

Z

Declaration of Conformity

Series EZ-ZONE[®] ST Tower



WATLOW
1241 Bundy Blvd.
Winona, MN 55987 USA

an ISO 9001 approved facility since 1996.

Declares that the following product:

Designation: **Series EZ-ZONE[®] ST Tower**

Model Numbers: ST, followed by K, B, P, E, H, D, J or C, followed by A, L or B, followed by A, B or F, followed by L, H, 1, 2 or 3, followed by any letter or number, followed by A – H, J – N, P, R, S or T, followed by A, B, C, D, E or F followed by any three numbers or letters.

Classification: Temperature control, Installation Category II, Pollution degree 2, IP20

Rated Voltage and Frequency: Control 100 to 240 V~ ac or 24 to 28 V□ ac or dc (ac = 50/60 Hz)
Load 24 to 240 V~ ac or 48 to 600 V~ ac zero cross, or
Load 100 to 240 V~ ac or 260 to 600 V~ ac phase angle³.

Rated Power Consumption: Control 12 VA, Control with Contactor 50 VA, Control with external contactor 140 VA. Load Current 25, 40 or 75A depending upon SSR and heatsink used. (see derating curve)

Meets the essential requirements of the following European Union Directives by using the relevant standards show below to indicate compliance.

2004/108/EC Electromagnetic Compatibility Directive

EN 61326-1	2006	Electrical equipment for measurement, control and laboratory use – EMC requirements (Industrial Immunity, Class A Emissions¹). <i>Not for use in a Class B environment without additional filtering.</i>
EN 61000-4-2	1996 +A1,A2:2001	Electrostatic Discharge Immunity
EN 61000-4-3	2006	Radiated Field Immunity
EN 61000-4-4	2004	Electrical Fast-Transient / Burst Immunity
EN 61000-4-5	2006	Surge Immunity
EN 61000-4-6	1996 +A1,A2,A3:2005	Conducted Immunity
EN 61000-4-8	1994 +A1, 2001	Magnetic Field Immunity
EN 61000-4-11	2004	Voltage Dips, Short Interruptions and Voltage Variations Immunity
EN 61000-3-2 ⁴	2006	Harmonic Current Emissions
EN 61000-3-3 ²	2005	Voltage Fluctuations and Flicker
SEMI F47	2000	Specification for Semiconductor Sag Immunity Figure R1-1

¹NOTE 1: Use of an external filter is required to comply with conducted emissions limits for load terminals. For 230 Vac or less, use Watlow P/N 14-0019 or Crydom P/N 1F25 filters. For voltages up to 440 Vac use Watlow P/N 14-0020 or Crydom P/N 3F20 filters. A Line Impedance Stabilization Network (LISN) was used for conducted emissions measurements.

²NOTE 2: To comply with flicker requirements cycle time may need to be greater than 175 seconds if Load Power is $\leq 16A$ to comply with standard, or the maximum source impedance needs to be determined. Source impedance shall meet EN 61000-3-11 requirements for load currents $> 16A$. Control module power complies with 61000-3-3 requirements.

Declaration of Conformity (cont.)

³NOTE 3: For Phase Angle control models, filtering in addition to that recommended in NOTE 1 will be needed to comply with conducted emissions requirements, consult factory for details.

⁴NOTE 4: Phase angle models will need power factor correction to pass harmonic current standard.

2006/95/EC Low-Voltage Directive

EN 61010-1 2001 Safety Requirements of electrical equipment for measurement, control and laboratory use. Part 1: General requirements

Compliant with 2002/95/EC RoHS Directive

Per 2002/96/EC WEEE Directive  Please Recycle Properly

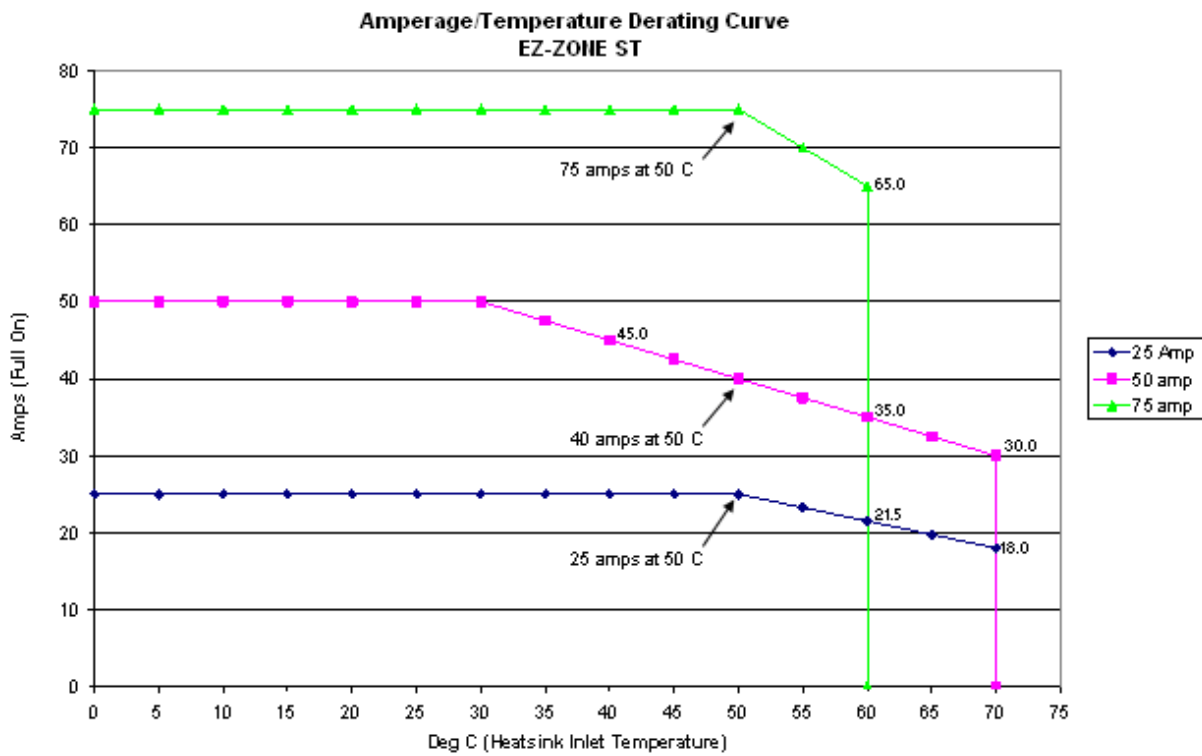

Raymond D. Feller III
Name of Authorized Representative

Winona, Minnesota, USA
Place of Issue

General Manager
Title of Authorized Representative

January 2010
Date of Issue

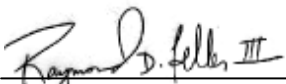
Signature of Authorized Representative

How to Reach Us

Corporate Headquarters

Watlow Electric Manufacturing Company
12001 Lackland Road
St. Louis, MO 63146
Sales: 1-800-WATLOW2
Manufacturing Support: 1-800-4WATLOW
Email: info@watlow.com
Website: www.watlow.com
From outside the USA and Canada:
Tel: +1 (314) 878-4600
Fax: +1 (314) 878-6814

Latin America

Watlow de México S.A. de C.V.
Av. Fundición No. 5
Col. Parques Industriales
Querétaro, Qro. CP-76130
Mexico
Tel: +52 442 217-6235
Fax: +52 442 217-6403

Europe

Watlow France
Tour d'Asnières.
4 Avenue Laurent Cély
92600 Asnières sur Seine
France
Tél: + 33 (0)1 41 32 79 70
Télécopie: + 33(0)1 47 33 36 57
Email: info@watlow.fr
Website: www.watlow.fr

Watlow GmbH
Postfach 11 65, Lauchwasenstr. 1
D-76709 Kronau
Germany
Tel: +49 (0) 7253 9400-0
Fax: +49 (0) 7253 9400-900
Email: info@watlow.de
Website: www.watlow.de

Watlow Italy S.r.l.
Viale Italia 52/54
20094 Corsico MI
Italy
Tel: +39 024588841
Fax: +39 0245869954
Email: italyinfo@watlow.com
Website: www.watlow.it

Watlow Ibérica, S.L.U.
C/Marte 12, Posterior, Local 9
E-28850 Torrejón de Ardoz
Madrid - Spain
T. +34 91 675 12 92
F. +34 91 648 73 80
Email: info@watlow.es
Website: www.watlow.es

Watlow UK Ltd.
Linby Industrial Estate
Linby, Nottingham, NG15 8AA
United Kingdom
Telephone: (0) 115 964 0777
Fax: (0) 115 964 0071
Email: info@watlow.co.uk
Website: www.watlow.co.uk
From outside The United Kingdom:
Tel: +44 115 964 0777
Fax: +44 115 964 0071

Asia and Pacific

Watlow Singapore Pte Ltd.
16 Ayer Rajah Crescent,
#06-03/04,
Singapore 139965
Tel: +65 6773 9488 Fax: +65 6778 0323
Email: info@watlow.com.sg Website: www.watlow.com.sg

Watlow Australia Pty., Ltd.
4/57 Sharps Road
Tullamarine, VIC 3043
Australia
Tel: +61 3 9335 6449
Fax: +61 3 9330 3566
Website: www.watlow.com

Watlow Electric Manufacturing (Shanghai) Company
1118 Fangyuan Road, Anting Industrial Park, Jiading, Shanghai, PRC
201203
People's Republic of China
Tel: +86 21 39509510
Fax: +86 21 5080-0906
Email: info@watlow.cn
Website: www.watlow.cn

ワトロー・ジャパン株式会社
〒101-0047 東京都千代田区内神田1-14-4
四国ビル別館9階
Tel: 03-3518-6630 Fax: 03-3518-6632
Email: infoj@watlow.com Website: www.watlow.co.jp

Watlow Japan Ltd.
1-14-4 Uchikanda, Chiyoda-Ku
Tokyo 101-0047
Japan
Tel: +81-3-3518-6630 Fax: +81-3-3518-6632
Email: infoj@watlow.com Website: www.watlow.co.jp

Watlow Korea Co., Ltd.
#1406, E&C Dream Tower, 46, Yangpyeongdong-3ga
Yeongdeungpo-gu, Seoul 150-103
Republic of Korea
Tel: +82 (2) 2628-5770 Fax: +82 (2) 2628-5771
Website: www.watlow.co.kr

Watlow Malaysia Sdn Bhd
No. 14-3 Jalan 2/114
Kuchai Business Centre
Jalan Kuchai Lama
58200 Kuala Lumpur
Malaysia
Tel: +60 3 7980 7741 Fax: +60 3 7980 7739

瓦特龍電機股份有限公司
80143 高雄市前金區七賢二路189號 10樓之一
電話: 07-2885168 傳真: 07-2885568

Watlow Electric Taiwan Corporation
10F-1 No.189 Chi-Shen 2nd Road Kaohsiung 80143
Taiwan
Tel: +886-7-2885168 Fax: +886-7-2885568

Your Authorized Watlow Distributor

